

Features

- Low forward voltage drop
- High reverse voltage
- Hermetic metal cases with ceramic insulators

Typical Applications

- All purpose high power rectifier diodes
- High power resistance welding equipment
- Non-controllable and half-controllable rectifiers
- Controlled rectifiers

$I_{F(AV)}$ 8000A
 V_{RRM} 1100~2000 V
 I_{FSM} 94 kA
 I^2t 44180 10³A²S



SYMBOL	CHARACTERISTIC	TEST CONDITIONS		T _j (°C)	VALUE			UNIT
					Min	Type	Max	
$I_{F(AV)}$	Mean forward current	180° half sine wave 50Hz Double side cooled,	T _C =85°C	175			8000	A
V_{RRM}	Repetitive peak reverse voltage	tp=10ms		175	1100		2000	V
I_{RRM}	Repetitive peak current	at V _{RRM}		175			250	mA
I_{FSM}	Surge forward current	10ms half sine wave		175			94	kA
I^2t	I ² t for fusing coordination	V _R =0.6V _{RRM}					44180	A ² s*10 ³
V_{FO}	Threshold voltage			175			0.85	V
r_F	Forward slope resistance						0.071	mΩ
V_{FM}	Peak forward voltage	I _{FM} =6000A, F=90kN		175			1.28	V
Q_{rr}	Recovery charge	I _{FM} =2000A, tp=2000μs, di/dt=-20A/μs, V _R =50V		175		6500		μC
$R_{th(j-c)}$	Thermal resistance Junction to case	DC double side cooled					0.005	°C/W
$R_{th(c-h)}$	Thermal resistance case to heat sink	Clamping force 90kN					0.0015	
F_m	Mounting force				81		108	kN
T_{stg}	Stored temperature				-40		175	°C
W_t	Weight					2000		g
Outline	P48							

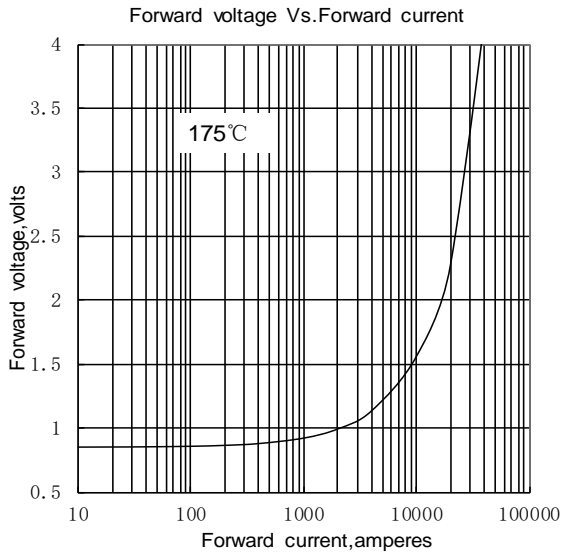

Fig.1

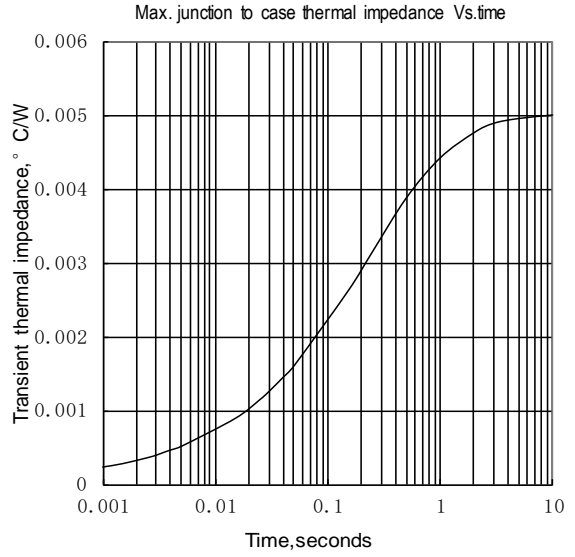

Fig.2

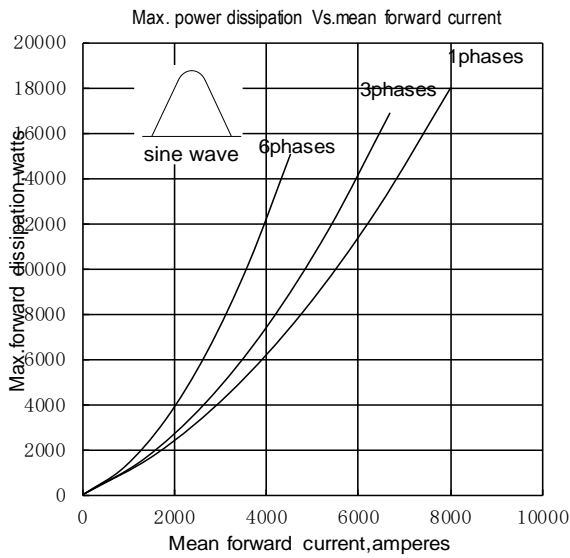

Fig.3

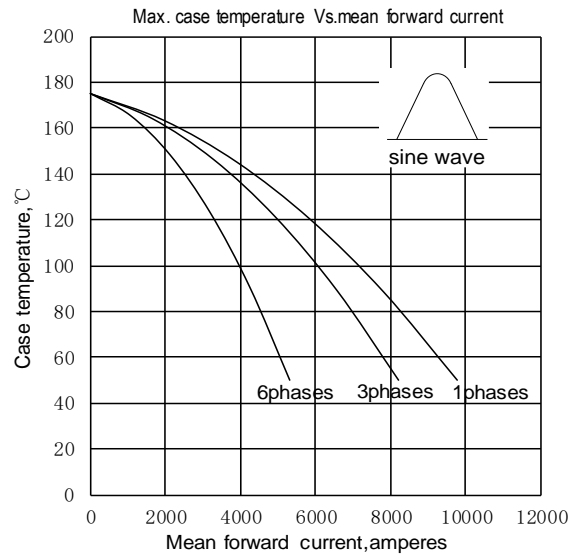

Fig.4

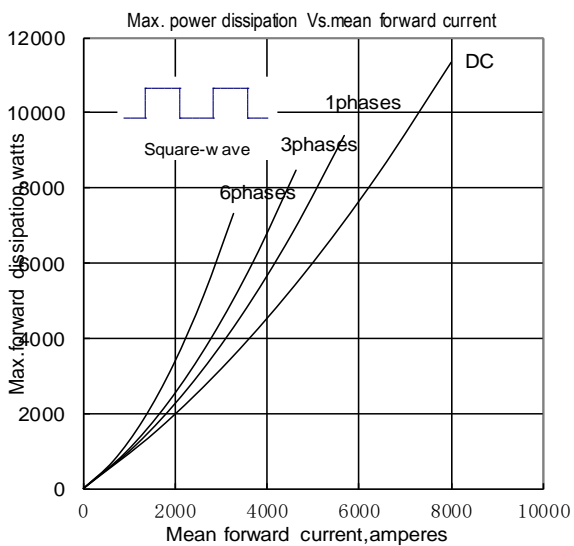

Fig.5

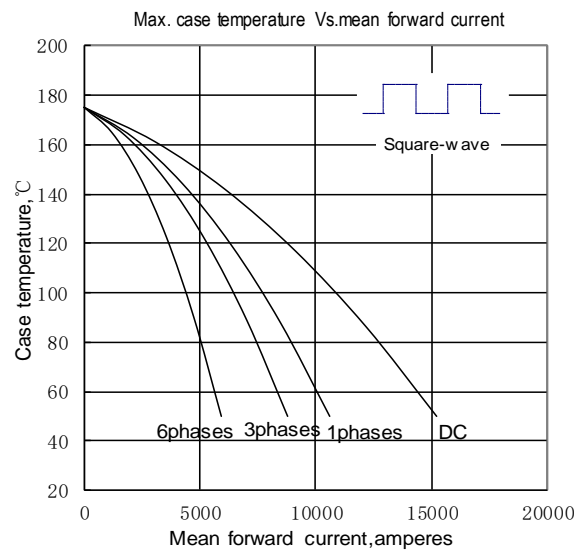

Fig.6

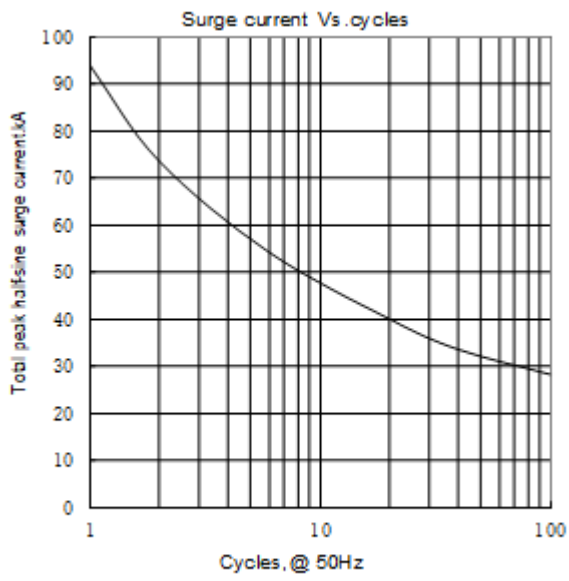
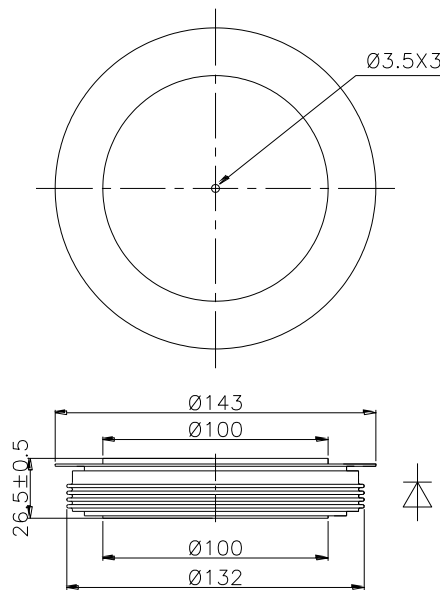

Fig.7



Nlps reserves the right to change specifications without notice.