

Features

- Center amplifying gate
- Metal case with ceramic insulator
- Low on-state and switching losses

Typical Applications

- AC controllers
- DC and AC motor control
- Controlled rectifiers

$I_{T(AV)}$ 550A
 V_{DRM}/V_{RRM} 200~600V
 I_{TSM} 8.0 kA
 I^2t 320 10³A²S



SYMBOL	CHARACTERISTIC	TEST CONDITIONS		T _i (°C)	VALUE			UNIT
					Min	Type	Max	
$I_{T(AV)}$	Mean on-state current	180° half sine wave 50Hz Double side cooled	$T_C=70^{\circ}C$				550	
V_{DRM} V_{RRM}	Repetitive peak off-state voltage Repetitive peak reverse voltage	tp=10ms		125	200		600	V
I_{DRM} I_{RRM}	Repetitive peak current	at V_{DRM} at V_{RRM}		125			16	mA
I_{TSM}	Surge on-state current	10ms half sine wave		125			8	kA
I^2t	I^2t for fusing coordination	$V_R=0.6V_{RRM}$						320
V_{TO}	Threshold voltage			125			0.75	V
r_T	On-state slope resistance							0.36
V_{TM}	Peak on-state voltage	$I_{TM}=1000A, F=5.0kN$		25			1.11	V
dv/dt	Critical rate of rise of off-state voltage	$V_{DM}=0.67V_{DRM}$		125			1000	V/μs
di/dt	Critical rate of rise of on-state current	$V_{DM}= 67\%V_{DRM}$ to 800A, Gate pulse $t_r \leq 0.5\mu s$ $I_{GM}=1.5A$		125			100	A/μs
Q_{rr}	Recovery charge	$I_{TM}=600A, tp=2000\mu s, di/dt=-20A/\mu s,$ $V_R =50V$		125		600		μC
I_{GT}	Gate trigger current			25	30		200	mA
V_{GT}	Gate trigger voltage	$V_A=12V, I_A=1A$			0.8		2.0	V
I_H	Holding current				20		150	mA
V_{GD}	Non-trigger gate voltage	$V_{DM}=67\%V_{DRM}$		125	0.3			V
$R_{th(j-c)}$	Thermal resistance Junction to case	DC: double side cooled Clamping force 5.0kN					0.080	°C /W
$R_{th(c-h)}$	Thermal resistance case to heat sink							
F_m	Mounting force				3.3		5.5	kN
T_{stg}	Stored temperature				-40		140	°C
W_t	Weight					60		g
Outline	P01							

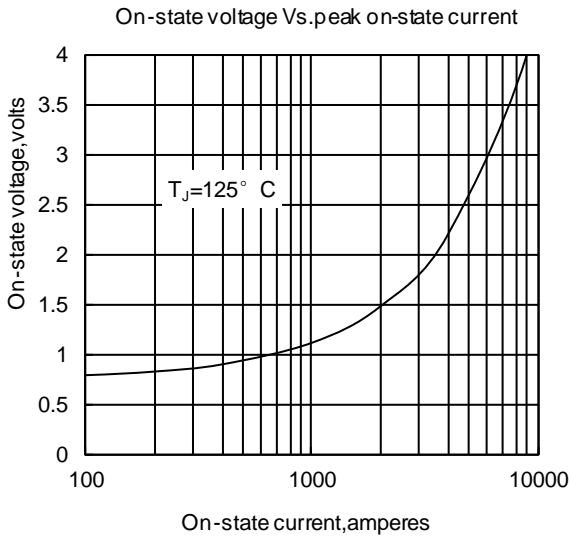

Fig1

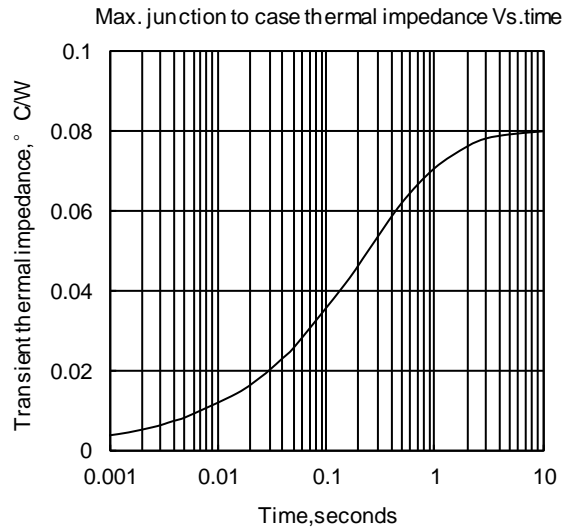

Fig2

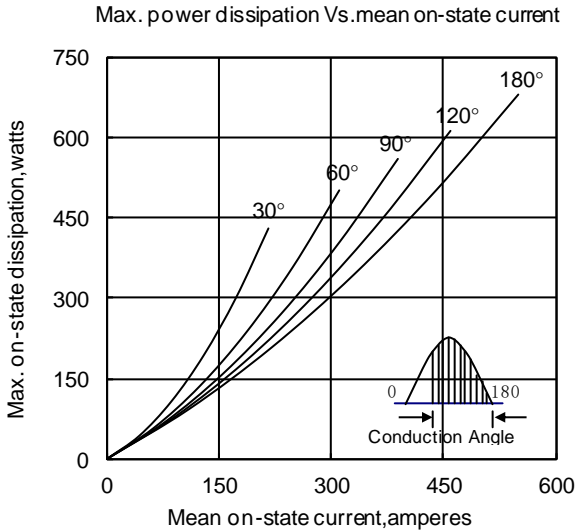

Fig3

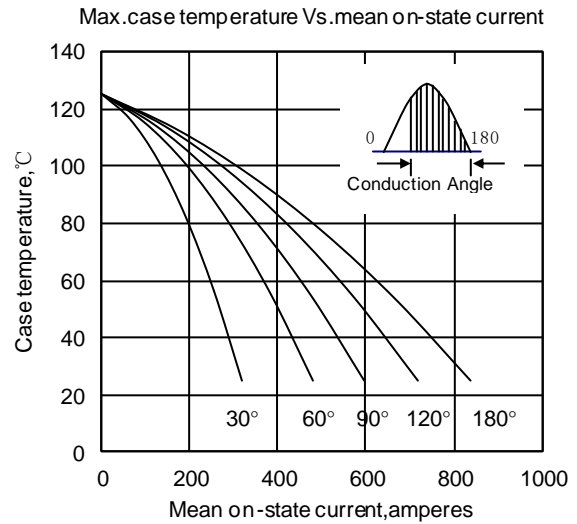

Fig4

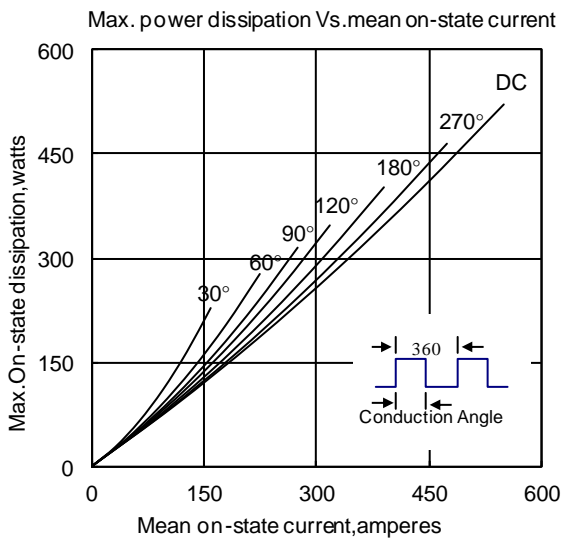

Fig5

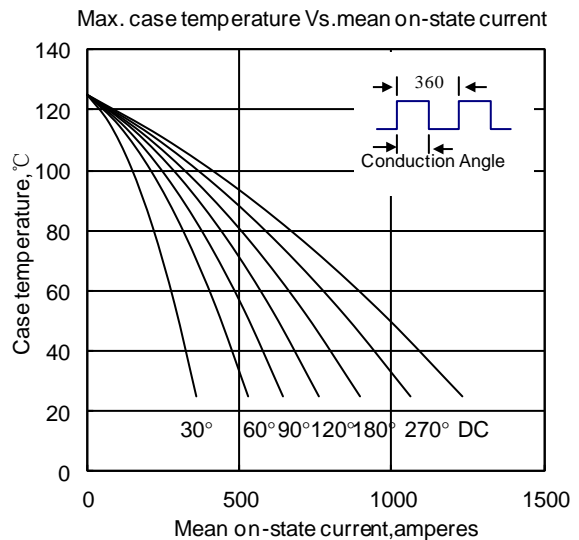

Fig6

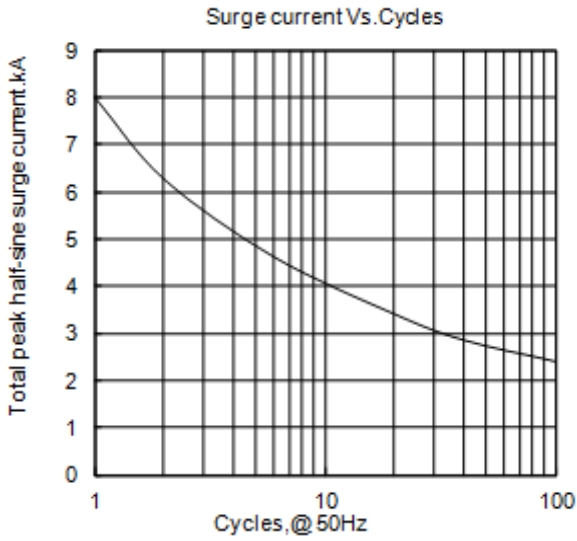

Fig7

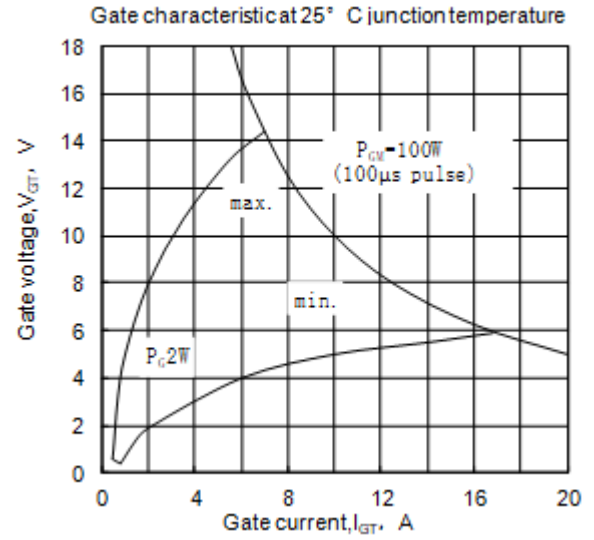

Fig8

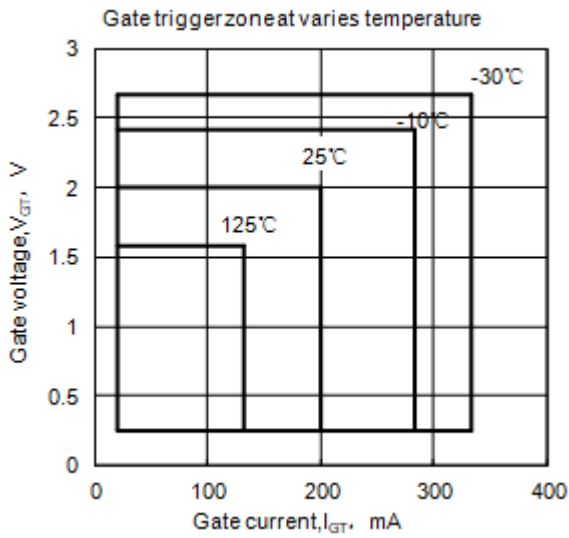
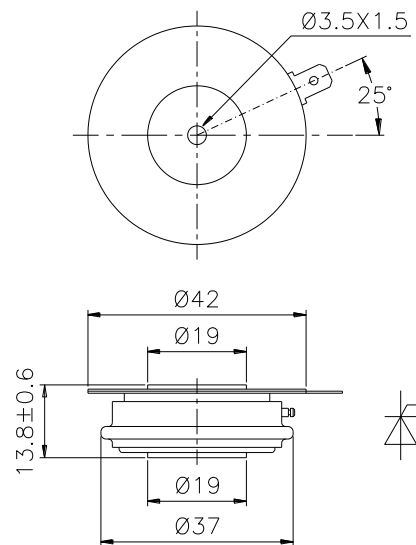

Fig9



Nlps reserves the right to change specifications without notice.