

**Features**

- Center amplifying gate
- Metal case with ceramic insulator
- Low on-state and switching losses

**Typical Applications**

- AC controllers
- DC and AC motor control
- Controlled rectifiers

$I_{T(AV)}$       **4900 A**  
 $V_{DRM}/V_{RRM}$     **400-1000V**  
 $I_{TSM}$             **66 kA**  
 $I^2t$                 **21780 10<sup>3</sup>A<sup>2</sup>S**

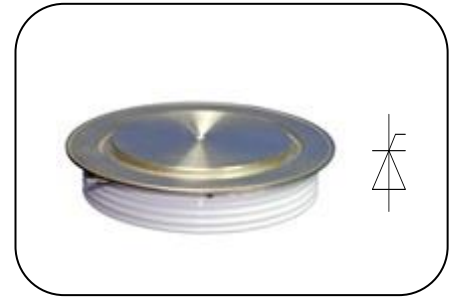

SYMBOL	CHARACTERISTIC	TEST CONDITIONS		T <sub>J</sub> (°C)	VALUE			UNIT
					Min	Type	Max	
I <sub>T(AV)</sub>	Mean on-state current	180° half sine wave 50Hz Double side cooled,	T <sub>C</sub> =70°C				4900	
V <sub>DRM</sub> V <sub>RRM</sub>	Repetitive peak off-state voltage Repetitive peak reverse voltage	tp=10ms		125	400		1000	V
I <sub>DRM</sub> I <sub>RRM</sub>	Repetitive peak current	at V <sub>DRM</sub> at V <sub>RRM</sub>		125			250	mA
I <sub>TSM</sub>	Surge on-state current	10ms half sine wave		125			66	kA
I <sup>2</sup> t	I <sup>2</sup> t for fusing coordination	V <sub>R</sub> =0.6V <sub>RRM</sub>						21780
V <sub>TO</sub>	Threshold voltage			125			0.88	V
r <sub>T</sub>	On-state slope resistance							0.06
V <sub>TM</sub>	Peak on-state voltage	I <sub>TM</sub> =5000A, F=70kN		25			1.18	V
dv/dt	Critical rate of rise of off-state voltage	V <sub>DM</sub> =0.67V <sub>DRM</sub>		125			1000	V/μs
di/dt	Critical rate of rise of on-state voltage current	V <sub>DM</sub> = 67%V <sub>DRM</sub> to 4000A, Gate pulse t <sub>r</sub> ≤0.5μs I <sub>GM</sub> =1.5A		125			250	A/μs
Q <sub>rr</sub>	Recovery charge	I <sub>TM</sub> =2000A, tp=2000μs, di/dt=-20A/μs, V <sub>R</sub> =50V		125		3000		μC
I <sub>GT</sub>	Gate trigger current			25	40		300	mA
V <sub>GT</sub>	Gate trigger voltage	V <sub>A</sub> =12V, I <sub>A</sub> =1A			0.8		3.0	V
I <sub>H</sub>	Holding current				20		300	mA
V <sub>GD</sub>	Non-trigger gate voltage	V <sub>DM</sub> =67%V <sub>DRM</sub>		125	0.3			V
R <sub>th(j-c)</sub>	Thermal resistance Junction to case	DC: double side cooled Clamping force 70.0kN					0.007	°C /W
R <sub>th(c-h)</sub>	Thermal resistance case to heatsink						0.002	
F <sub>m</sub>	Mounting force				63		84	kN
T <sub>stg</sub>	Stored temperature				-40		140	°C
W <sub>t</sub>	Weight					1390		g
Outline	P20							

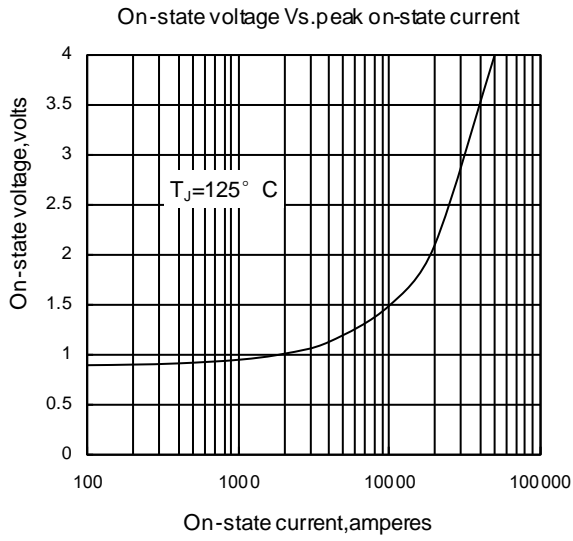

Fig1

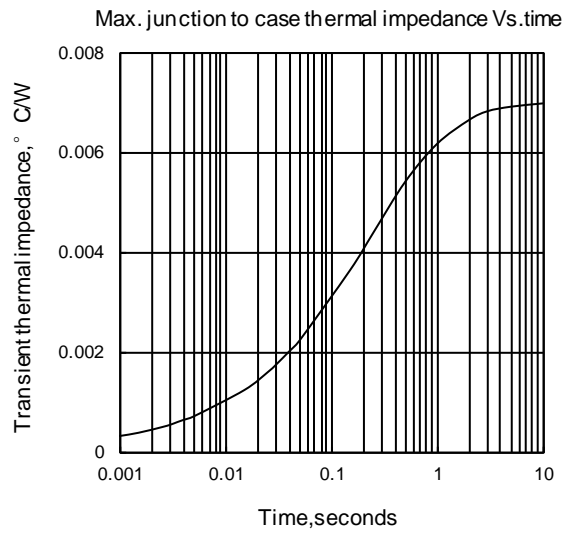

Fig2

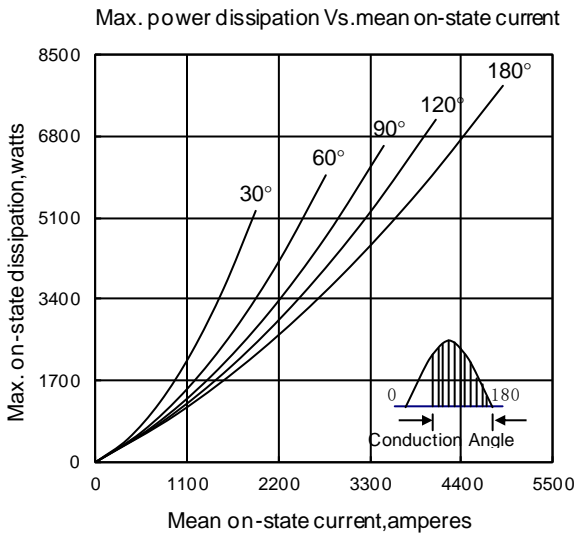

Fig3

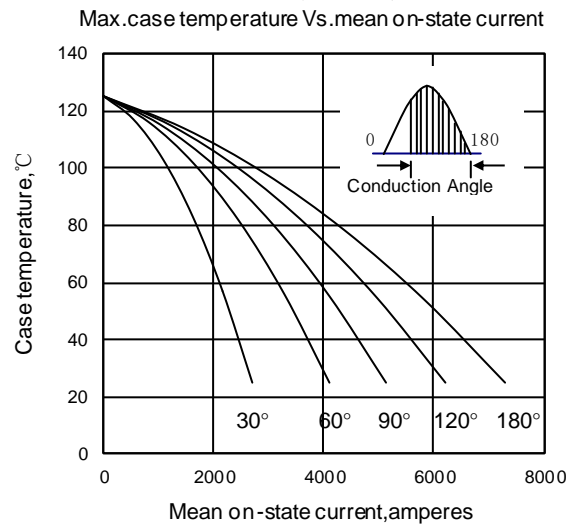

Fig4

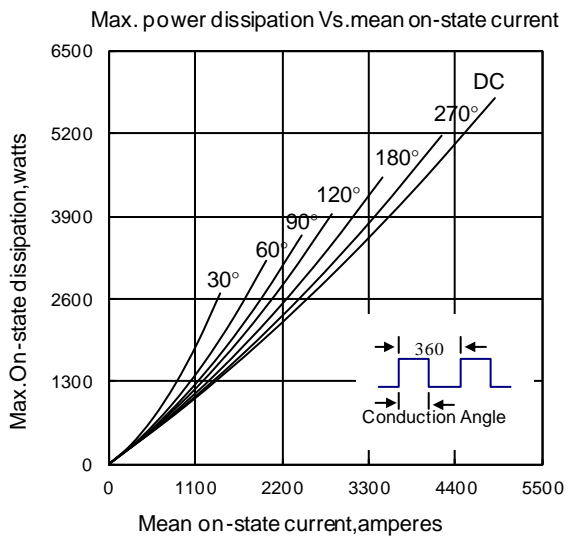

Fig5

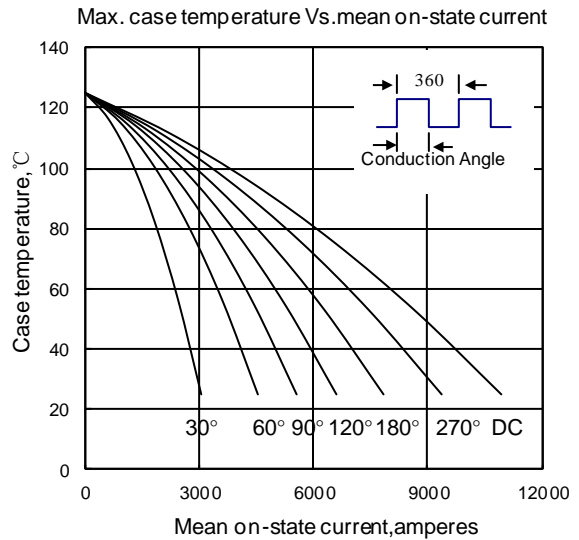

Fig6

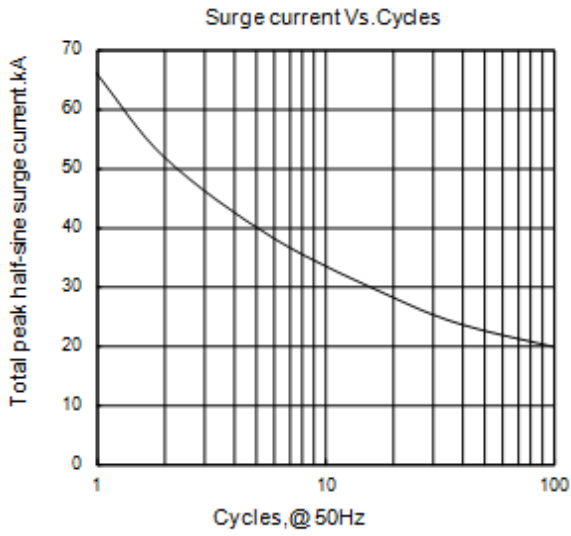

Fig7

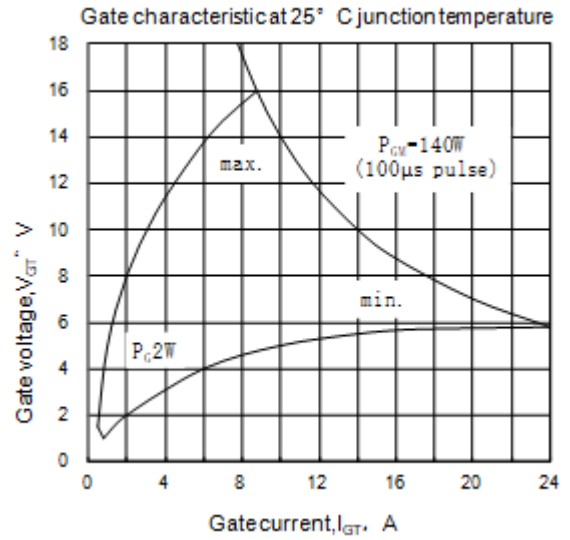

Fig8

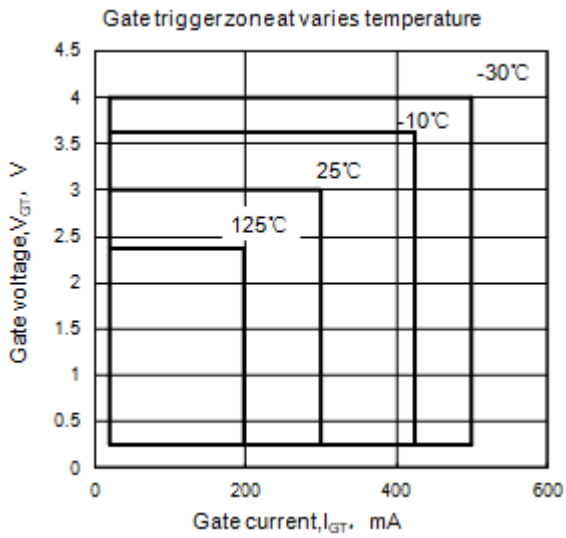
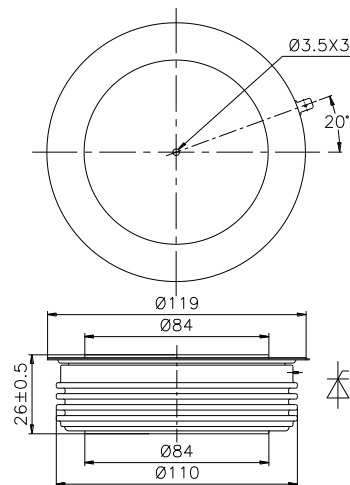

Fig9



Nlps reserves the right to change specifications without notice.