

Features

- Center amplifying gate
- Metal case with ceramic insulator
- Low on-state and switching losses

Typical Applications

- AC controllers
- DC and AC motor control
- Controlled rectifiers

$I_{T(AV)}$ **450A**
 V_{DRM}/V_{RRM} **400~1000V**
 I_{TSM} **6.3 kA**
 I^2t **198.45 10³A²S**



SYMBOL	CHARACTERISTIC	TEST CONDITIONS		T _j (°C)	VALUE			UNIT
					Min	Type	Max	
I _{T(AV)}	Mean on-state current	180° half sine wave 50Hz Double side cooled	T _C =70°C				450	
V _{DRM} V _{RRM}	Repetitive peak off-state voltage Repetitive peak reverse voltage	tp=10ms		125	400		1000	V
I _{DRM} I _{RRM}	Repetitive peak current	at V _{DRM} at V _{RRM}		125			16	mA
I _{TSM}	Surge on-state current	10ms half sine wave		125			6.3	kA
I ² t	I ² t for fusing coordination	V _R =0.6V _{RRM}					198.45	A ² s*10 ³
V _{TO}	Threshold voltage			125			0.75	V
r _T	On-state slope resistance						0.70	mΩ
V _{TM}	Peak on-state voltage	I _{TM} =770A, F=5.0kN		25			1.29	V
dv/dt	Critical rate of rise of off-state voltage	V _{DM} =0.67V _{DRM}		125			1000	V/μs
di/dt	Critical rate of rise of on-state current	V _{DM} = 67%V _{DRM} to 800A, Gate pulse t _r ≤0.5μs I _{GM} =1.5A		125			100	A/μs
Q _{rr}	Recovery charge	I _{TM} =500A, tp=2000μs, di/dt=-20A/μs, V _R =50V		125		800		μC
I _{GT}	Gate trigger current			25	30		200	mA
V _{GT}	Gate trigger voltage	V _A =12V, I _A =1A			0.8		2.0	V
I _H	Holding current				20		150	mA
V _{GD}	Non-trigger gate voltage	V _{DM} =67%V _{DRM}		125	0.3			V
R _{th(j-c)}	Thermal resistance Junction to case	DC: double side cooled Clamping force 5.0kN					0.080	°C/W
R _{th(c-h)}	Thermal resistance case to heat sink						0.020	
F _m	Mounting force				3.3		5.5	kN
T _{stg}	Stored temperature				-40		140	°C
W _t	Weight					60		g
Outline	P01							

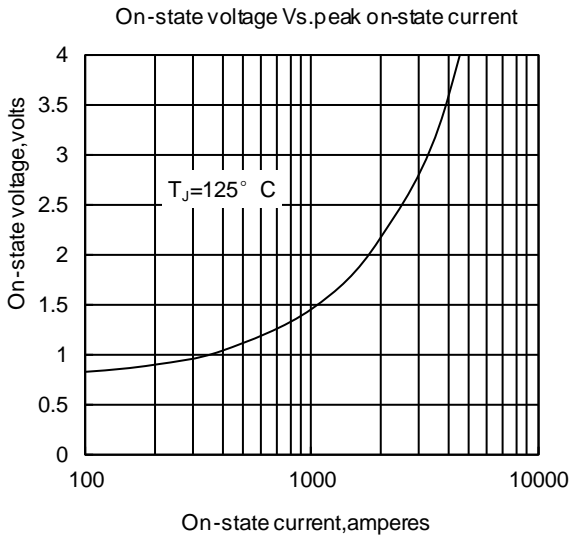

Fig1

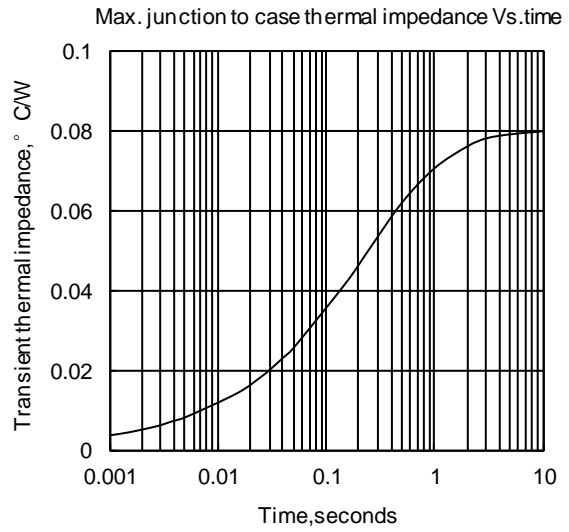

Fig2

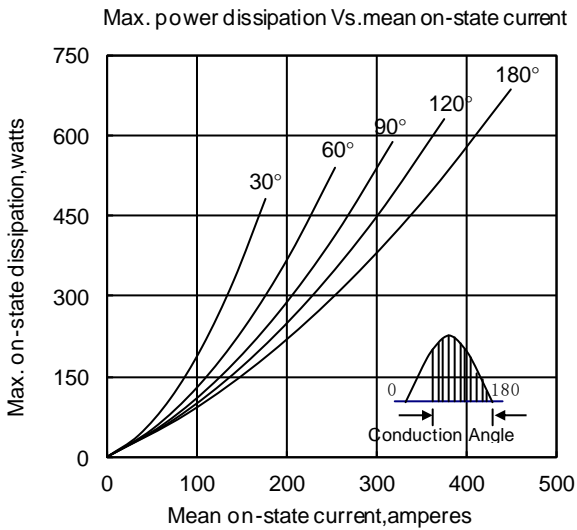

Fig3

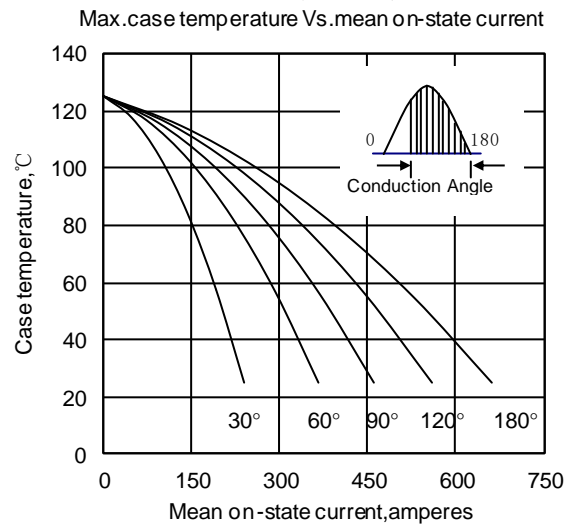

Fig4

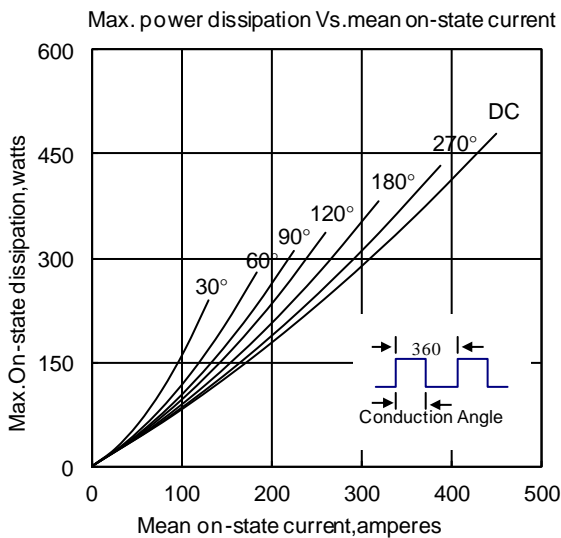

Fig5

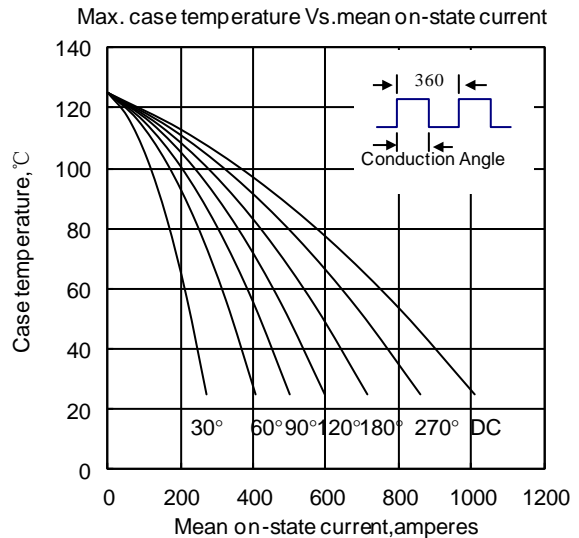

Fig6

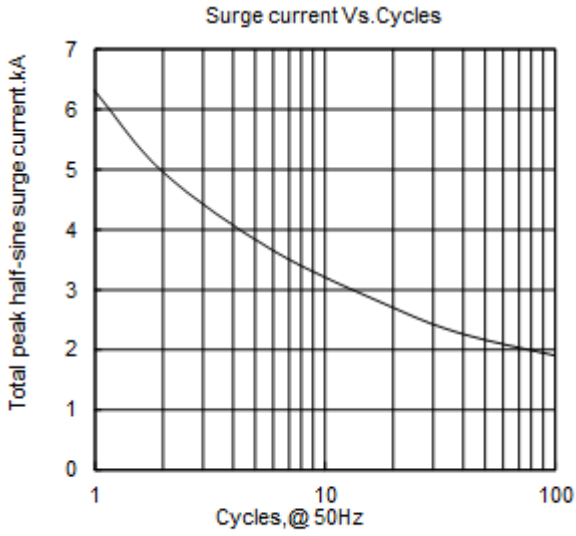

Fig7

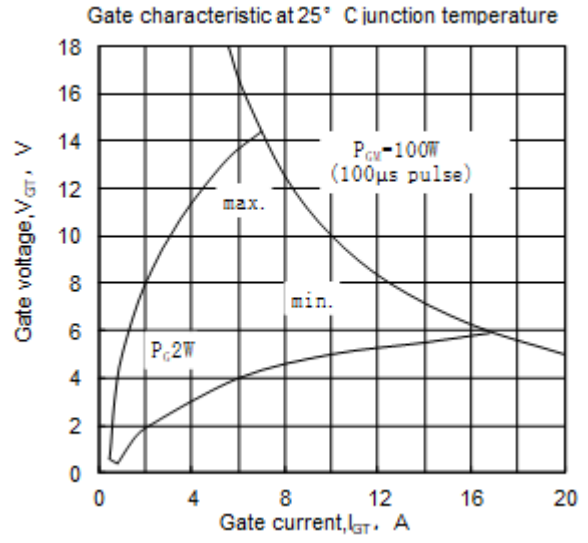

Fig8

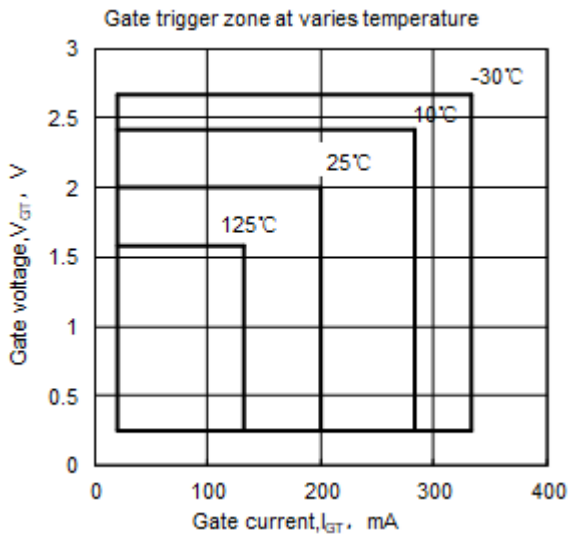
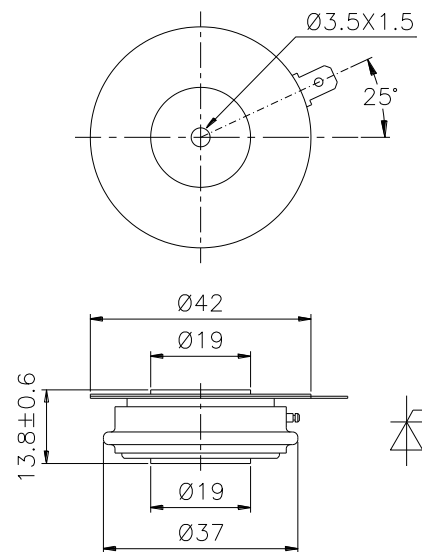

Fig9



Nlps reserves the right to change specifications without notice.