

**Features**

- Center amplifying gate
- Metal case with ceramic insulator
- Low on-state and switching losses

**Typical Applications**

- AC controllers
- DC and AC motor control
- Controlled rectifiers

**$I_{T(AV)}$  440A**  
 **$V_{DRM}/V_{RRM}$  4500~5500V**  
 **$I_{TSM}$  4.5 kA**  
 **$I^2t$  101 10<sup>3</sup>A<sup>2</sup>S**

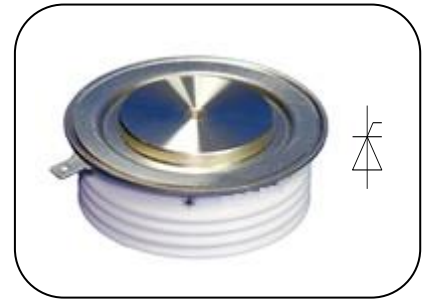

SYMBOL	CHARACTERISTIC	TEST CONDITIONS	T <sub>J</sub> (°C)	VALUE			UNIT
				Min	Type	Max	
I <sub>T(AV)</sub>	Mean on-state current	180° half sine wave 50Hz Double side cooled	T <sub>C</sub> =70°C	125		440	A
V <sub>DRM</sub> V <sub>RRM</sub>	Repetitive peak off-state voltage Repetitive peak reverse voltage	tp=10ms	125	4600		5500	V
I <sub>DRM</sub> I <sub>RRM</sub>	Repetitive peak current	at V <sub>DRM</sub> at V <sub>RRM</sub>	125			150	mA
I <sub>TSM</sub>	Surge on-state current	10ms half sine wave	125			4.5	kA
I <sup>2</sup> t	I <sup>2</sup> t for fusing coordination	V <sub>R</sub> =0.6V <sub>RRM</sub>				101	A <sup>2</sup> s*10 <sup>3</sup>
V <sub>TO</sub>	Threshold voltage		125			1.08	V
r <sub>T</sub>	On-state slope resistance					1.92	mΩ
V <sub>TM</sub>	Peak on-state voltage	I <sub>TM</sub> =1000A, F=15kN	125			2.80	V
dv/dt	Critical rate of rise of off-state voltage	V <sub>DM</sub> =0.67V <sub>DRM</sub>	125			2000	V/μs
di/dt	Critical rate of rise of on-state current	V <sub>DM</sub> = 67%V <sub>DRM</sub> to 1300A, Gate pulse t <sub>r</sub> ≤0.5μs I <sub>GM</sub> =1.5A	125			100	A/μs
Q <sub>rr</sub>	Recovery charge	I <sub>TM</sub> =1000A, tp=2000μs, di/dt=-5A/μs, V <sub>R</sub> =50V	125		2000		μC
I <sub>GT</sub>	Gate trigger current		25	40		300	mA
V <sub>GT</sub>	Gate trigger voltage	V <sub>A</sub> =12V, I <sub>A</sub> =1A		0.8		3.0	V
I <sub>H</sub>	Holding current			25		200	mA
V <sub>GD</sub>	Non-trigger gate voltage	V <sub>DM</sub> =0.67V <sub>DRM</sub>	125	0.3			V
R <sub>th(j-C)</sub>	Thermal resistance Junction to case	DC double side cooled				0.035	°C/W
R <sub>th(C-h)</sub>	Thermal resistance case to heatsink	Clamping force 15kN				0.008	°C/W
F <sub>m</sub>	Mounting force			10	15	20	kN
T <sub>stg</sub>	Stored temperature			-40		140	°C
W <sub>t</sub>	Weight				240		g
Outline		P08					

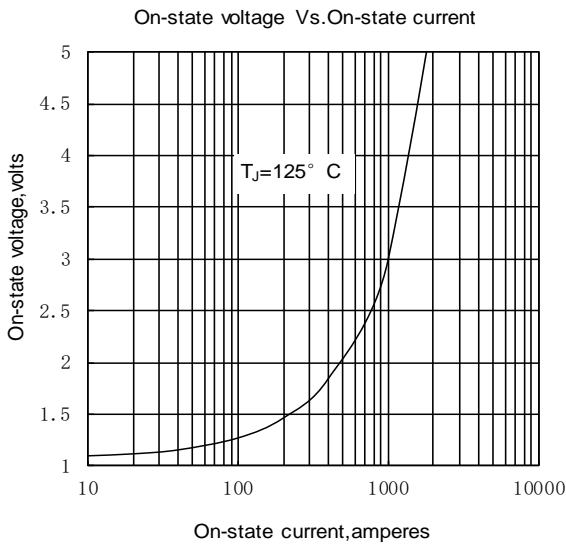

Fig.1

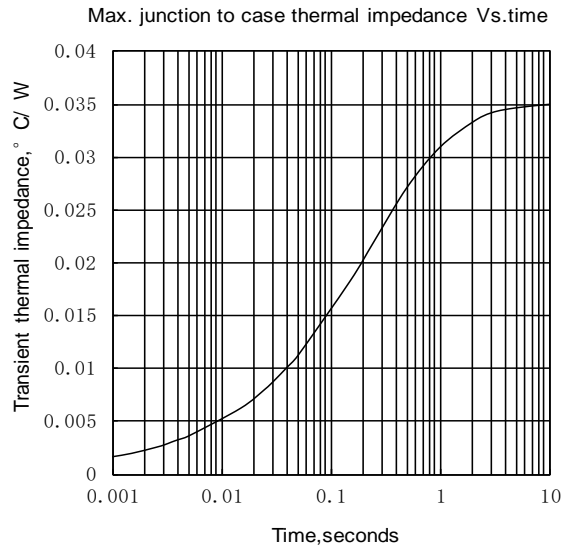

Fig.2

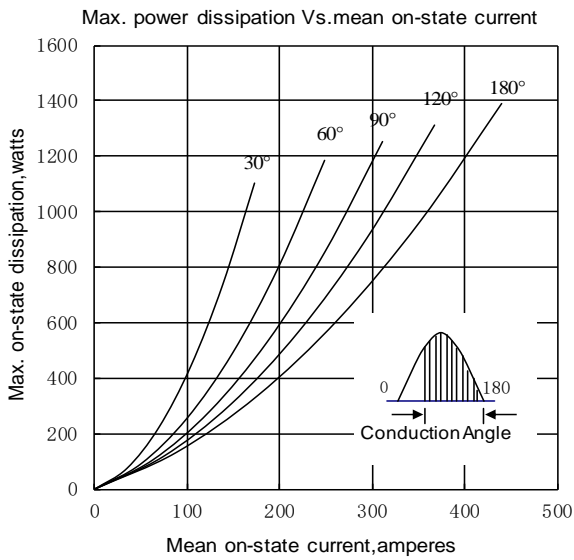

Fig.3

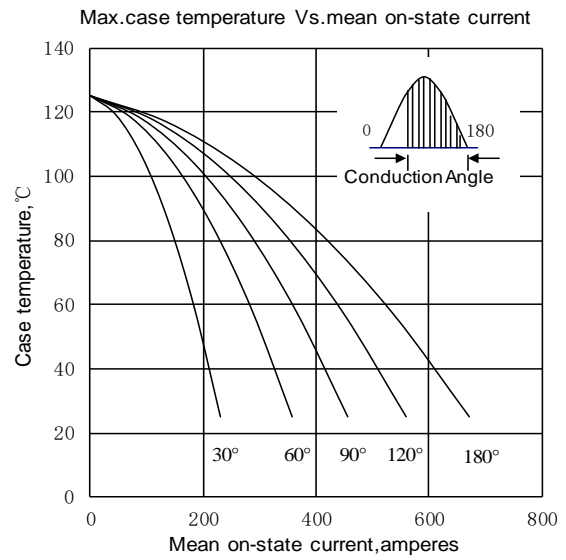

Fig.4

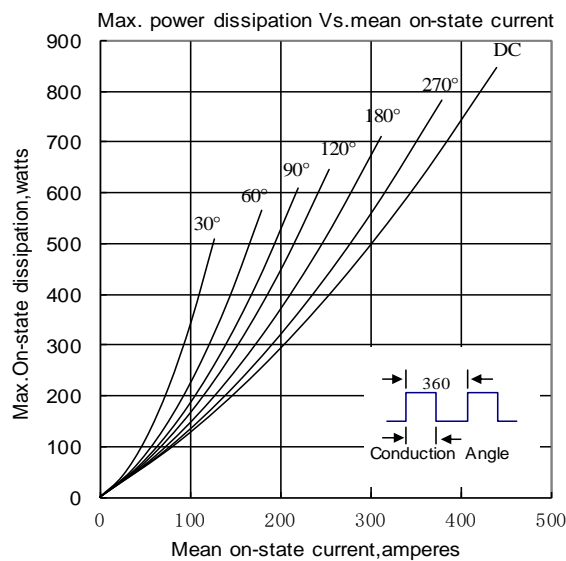

Fig.5

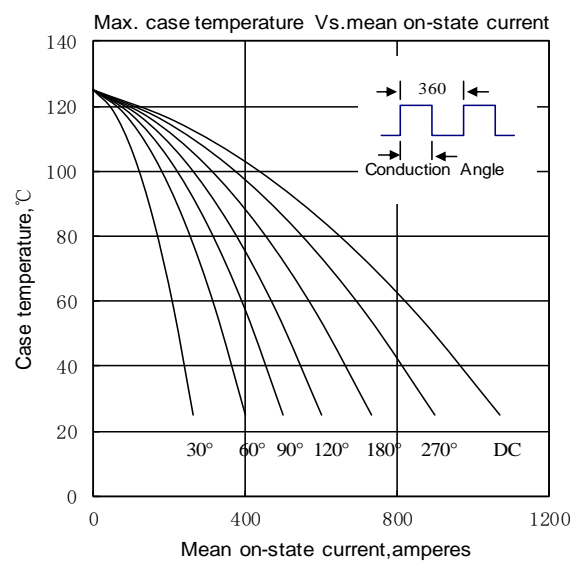

Fig.6

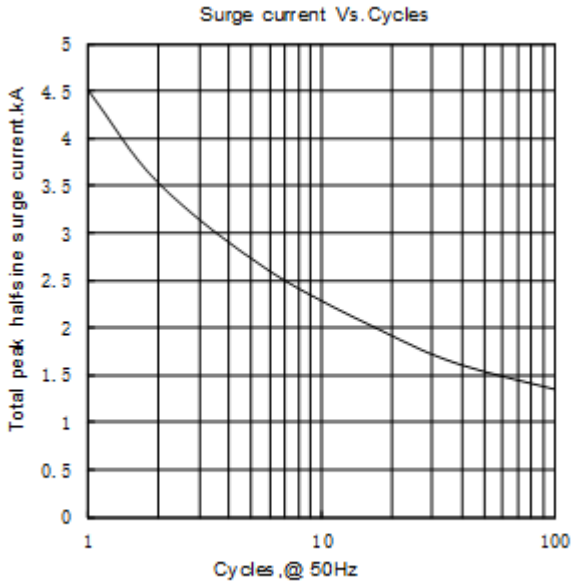

Fig.7

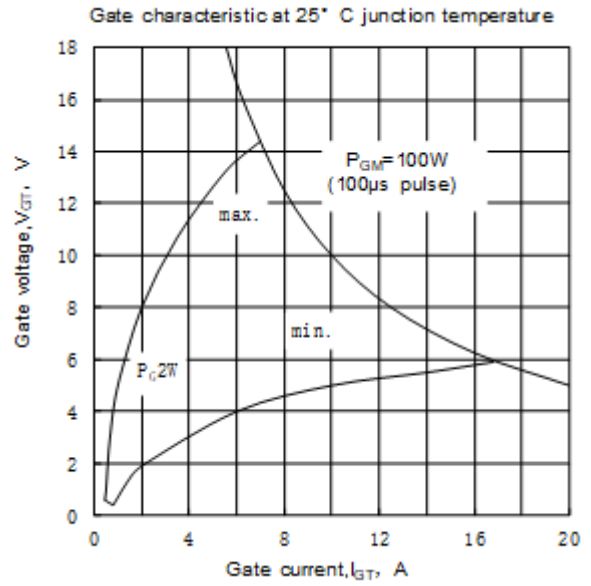

Fig.8

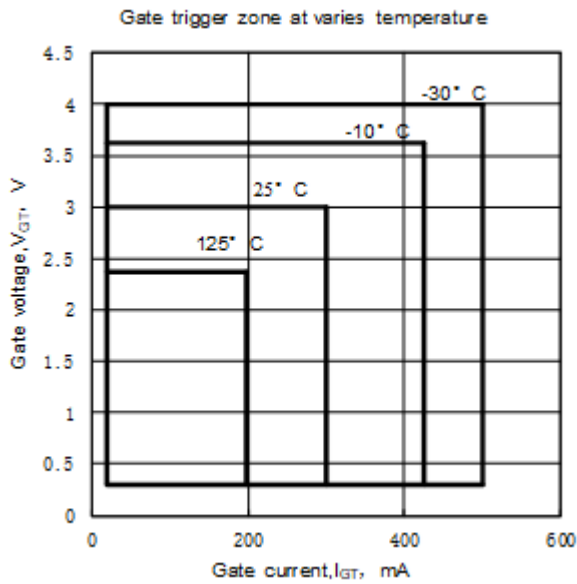
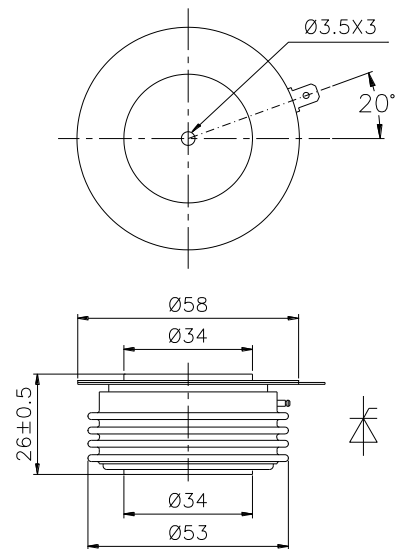

Fig.9



Nlps reserves the right to change specifications without notice.