

Features

- Center amplifying gate
- Metal case with ceramic insulator
- Low on-state and switching losses

Typical Applications

- AC controllers
- DC and AC motor control
- Controlled rectifiers

$I_{T(AV)}$ **3700 A**
 V_{DRM}/V_{RRM} **400-1000V**
 I_{TSM} **60 kA**
 I^2t **18000 10³A²S**



SYMBOL	CHARACTERISTIC	TEST CONDITIONS		T _J (°C)	VALUE			UNIT
					Min	Type	Max	
I _{T(AV)}	Mean on-state current	180° half sine wave 50Hz Double side cooled	T _C =70°C				3700	
V _{DRM} V _{RRM}	Repetitive peak off-state voltage Repetitive peak reverse voltage	tp=10ms		125	400		1000	V
I _{DRM} I _{RRM}	Repetitive peak current	at V _{DRM} at V _{RRM}		125			200	mA
I _{TSM}	Surge on-state current	10ms half sine wave		125			60	kA
I ² t	I ² t for fusing coordination	V _R =0.6V _{RRM}					18000	A ² s*10 ³
V _{TO}	Threshold voltage			125			0.86	V
r _T	On-state slope resistance						0.06	mΩ
V _{TM}	Peak on-state voltage	I _{TM} =5000A, F=40kN		25			1.17	V
dv/dt	Critical rate of rise of off-state voltage	V _{DM} =0.67V _{DRM}		125			1000	V/μs
di/dt	Critical rate of rise of on-state current	V _{DM} = 67%V _{DRM} to 4000A, Gate pulse t _r ≤0.5μs I _{GM} =1.5A		125			250	A/μs
Q _{rr}	Recovery charge	I _{TM} =2000A, tp=2000μs, di/dt=-20A/μs, V _R =50V		125		2400		μC
I _{GT}	Gate trigger current			25	40		300	mA
V _{GT}	Gate trigger voltage	V _A =12V, I _A =1A			0.8		3.0	V
I _H	Holding current				20		300	mA
V _{GD}	Non-trigger gate voltage	V _{DM} =67%V _{DRM}		125	0.3			V
R _{th(j-c)}	Thermal resistance Junction to case	DC: double side cooled					0.010	°C/W
R _{th(c-h)}	Thermal resistance case to heatsink	Clamping force 40.0kN					0.003	
F _m	Mounting force				35		47	kN
T _{stg}	Stored temperature				-40		140	°C
W _t	Weight					1100		g
Outline	P17							

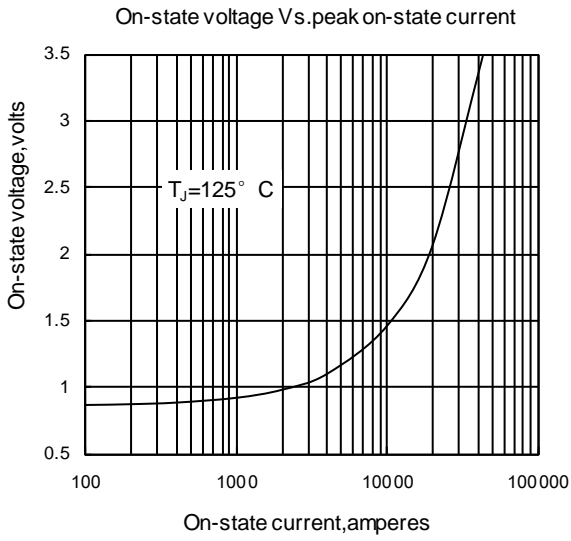

Fig1

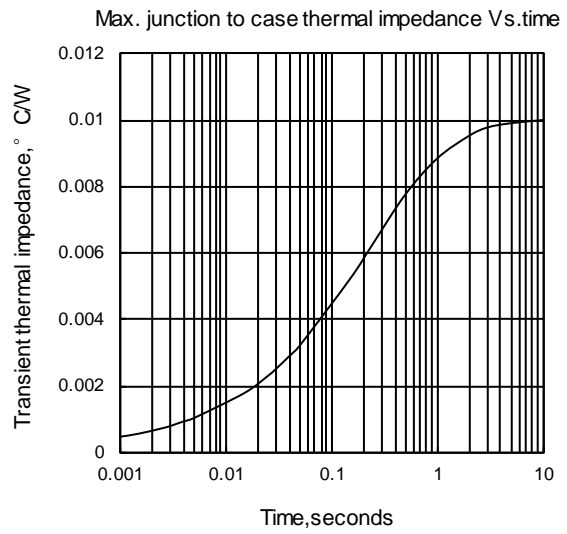

Fig2

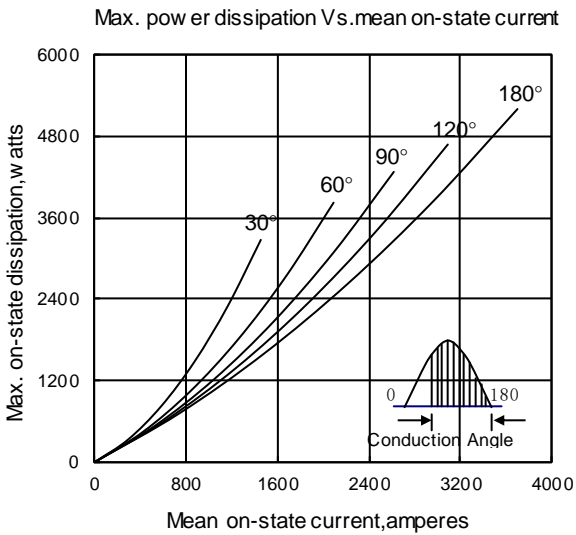

Fig3

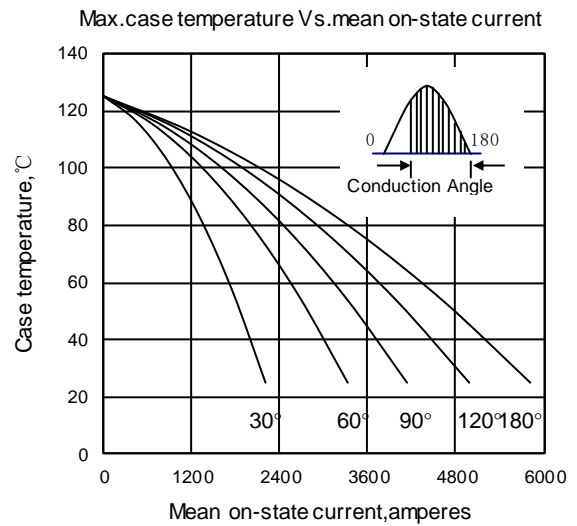

Fig4

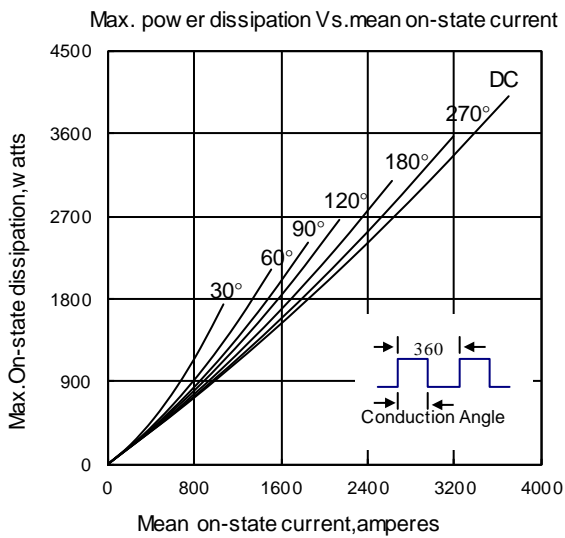

Fig5

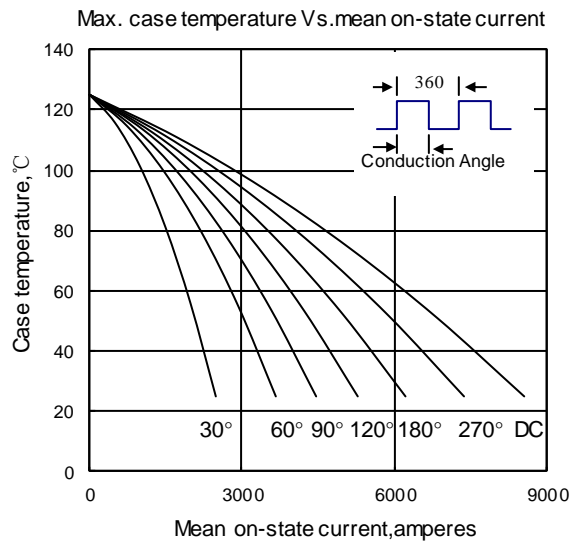

Fig6

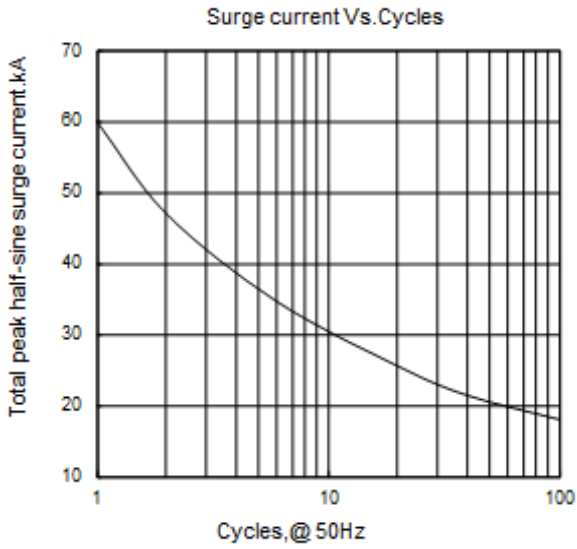

Fig7

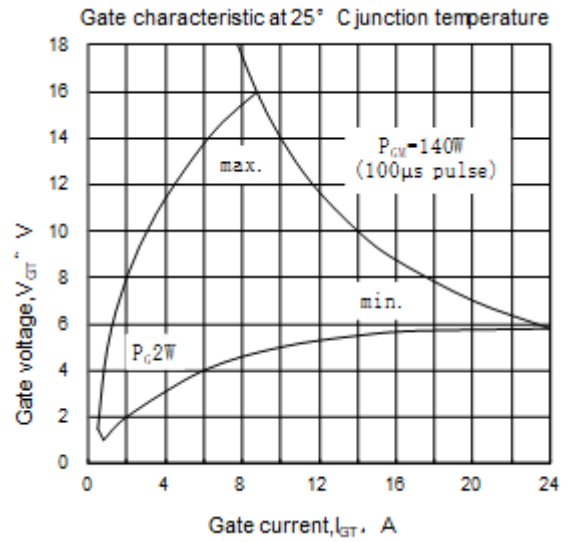

Fig8

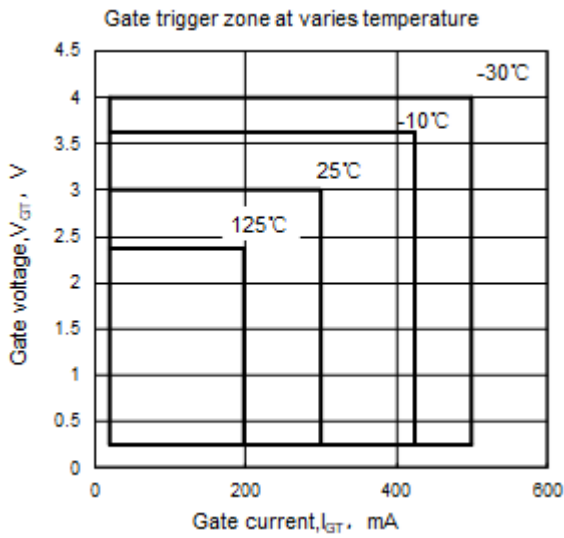
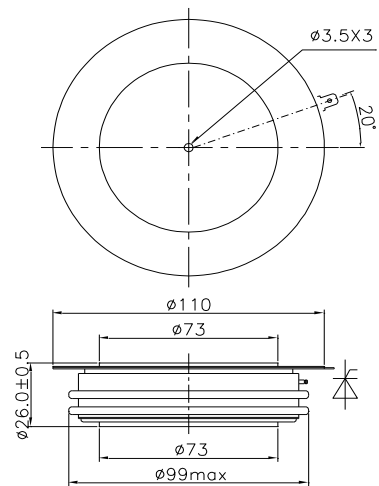

Fig9



Nlps reserves the right to change specifications without notice.