

Features

- Low forward voltage drop
- High reverse voltage
- Hermetic metal cases with ceramic insulators

Typical Applications

- All purpose high power rectifier diodes
- High power resistance welding equipment
- Non-controllable and half-controllable rectifiers
- Controlled rectifiers

$I_{F(AV)}$ 3180A
 V_{RRM} 200~1000 V
 I_{FSM} 30 kA
 I^2t 4500 10³A²S

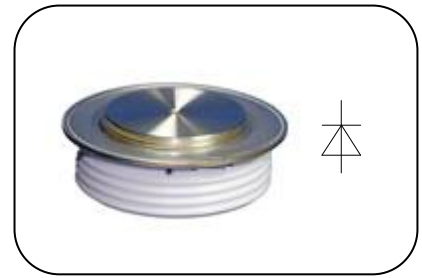

SYMBOL	CHARACTERISTIC	TEST CONDITIONS		T _j (°C)	VALUE			UNIT
					Min	Type	Max	
$I_{F(AV)}$	Mean forward current	180° half sine wave 50Hz Double side cooled,	T _C =85°C	190			3180	A
V_{RRM}	Repetitive peak reverse voltage	tp=10ms		190	200		1000	V
I_{RRM}	Repetitive peak current	at V_{RRM}		190			80	mA
I_{FSM}	Surge forward current	10ms half sine wave $V_R=0.6V_{RRM}$		190			30	kA
I^2t	I^2t for fusing coordination						4500	A ² s*10 ³
V_{FO}	Threshold voltage			190			0.79	V
r_F	Forward slope resistance						0.11	mΩ
V_{FM}	Peak forward voltage	$I_{FM}=2000A, F=24kN$		190			1.01	V
Q_{rr}	Recovery charge	$I_{FM}=2000A, tp=2000\mu s, di/dt=-20A/\mu s, V_R=50V$		190		3300		μC
$R_{th(j-c)}$	Thermal resistance Junction to case	DC: double side cooled Clamping force 24.0 kN					0.020	°C /W
$R_{th(c-h)}$	Thermal resistance case to heat sink						0.005	
F_m	Mounting force				19		26	kN
T_{stg}	Stored temperature				-40		190	°C
W_t	Weight					440		g
Outline	P42							

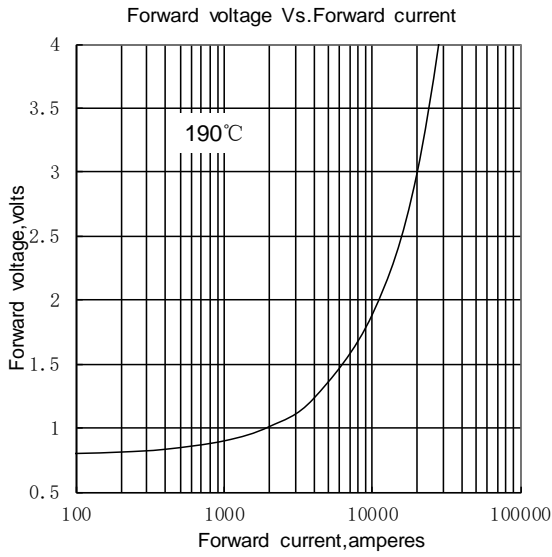

Fig.1

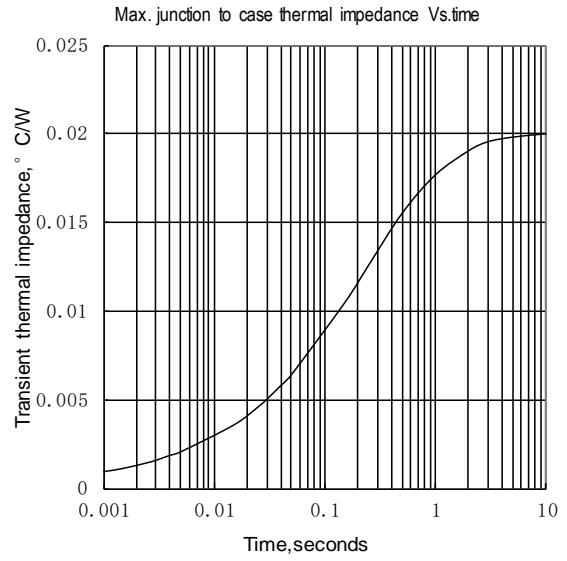

Fig.2

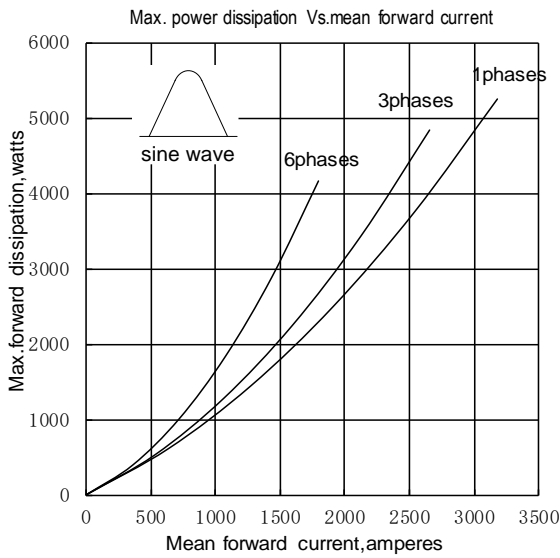

Fig.3

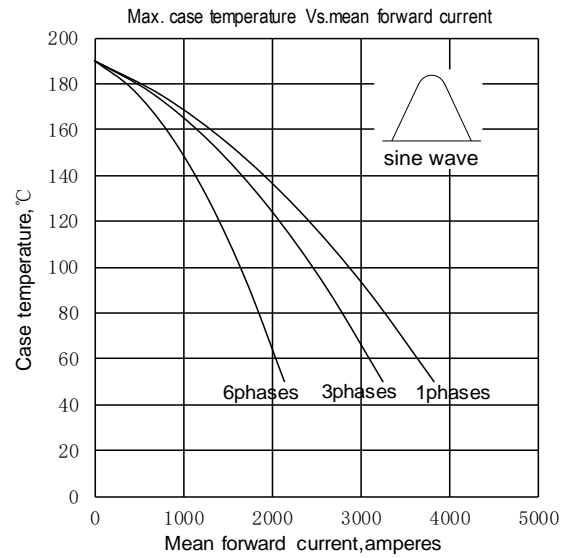

Fig.4

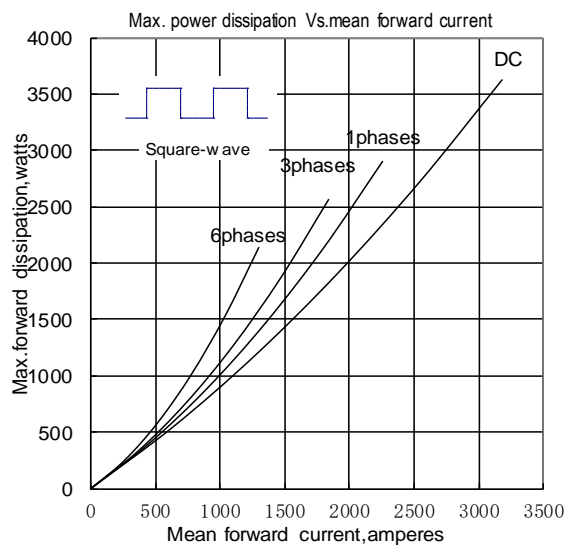

Fig.5

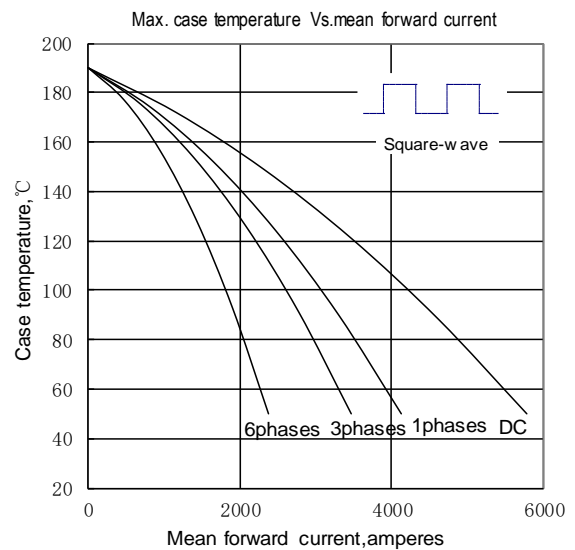

Fig.6

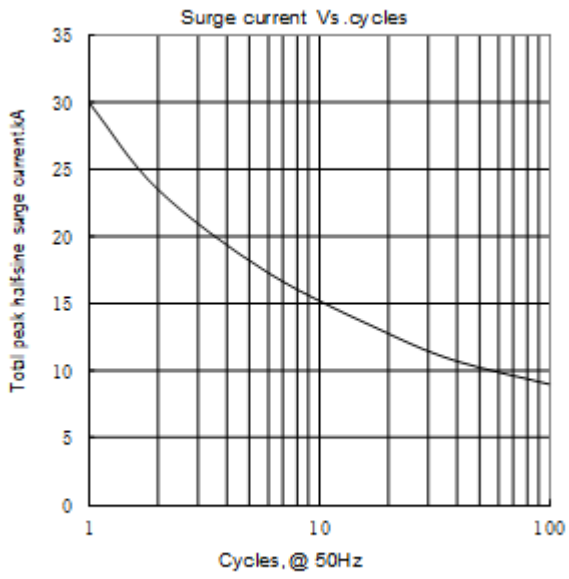
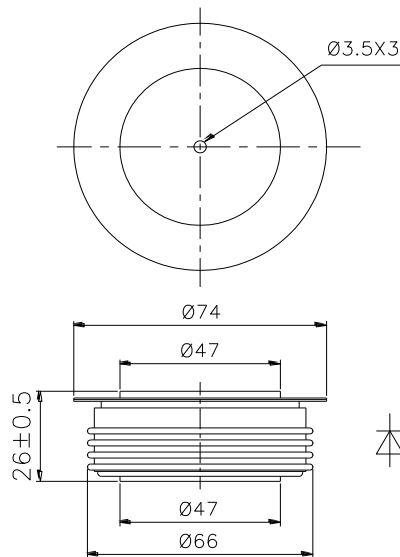

Fig.7



Nlps reserves the right to change specifications without notice.