

Features

- Center amplifying gate
- Metal case with ceramic insulator
- Low on-state and switching losses

Typical Applications

- AC controllers
- DC and AC motor control
- Controlled rectifiers

$I_{T(AV)}$ 3170 A
 V_{DRM}/V_{RRM} 400-1000V
 I_{TSM} 38 kA
 I^2t 7220 10³A²S



SYMBOL	CHARACTERISTIC	TEST CONDITIONS		T _i (°C)	VALUE			UNIT
					Min	Type	Max	
$I_{T(AV)}$	Mean on-state current	180° half sine wave 50Hz Double side cooled,	$T_C=70^{\circ}C$				3170	
V_{DRM} V_{RRM}	Repetitive peak off-state voltage Repetitive peak reverse voltage	tp=10ms		125	400		1000	V
I_{DRM} I_{RRM}	Repetitive peak current	at V_{DRM} at V_{RRM}		125			160	mA
I_{TSM}	Surge on-state current	10ms half sine wave		125			38	kA
I^2t	I^2t for fusing coordination	$V_R=0.6V_{RRM}$					7220	A ² s*10 ³
V_{TO}	Threshold voltage			125			0.82	V
r_T	On-state slope resistance						0.08	mΩ
V_{TM}	Peak on-state voltage	$I_{TM}=5000A, F= 35kN$		25			1.22	V
dv/dt	Critical rate of rise of off-state voltage	$V_{DM}=0.67V_{DRM}$		125			1000	V/μs
di/dt	Critical rate of rise of on-state current	$V_{DM}= 67\%V_{DRM}$ to 3000A, Gate pulse $t_r \leq 0.5\mu s$ $I_{GM}=1.5A$		125			250	A/μs
Q_{rr}	Recovery charge	$I_{TM}=2000A, tp=2000\mu s, di/dt=-20A/\mu s,$ $V_R =50V$		125		2000		μC
I_{GT}	Gate trigger current			25	40		300	mA
V_{GT}	Gate trigger voltage	$V_A=12V, I_A=1A$			0.8		3.0	V
I_H	Holding current				20		300	mA
V_{GD}	Non-trigger gate voltage	$V_{DM}=67\%V_{DRM}$		125	0.3			V
$R_{th(j-c)}$	Thermal resistance Junction to case	DC· double side cooled					0.0120	°C /W
$R_{th(c-h)}$	Thermal resistance case to heatsink	Clamping force 35.0kN					0.0035	
F_m	Mounting force				30		40	kN
T_{stg}	Stored temperature				-40		140	°C
W_t	Weight					880		g
Outline	P15							

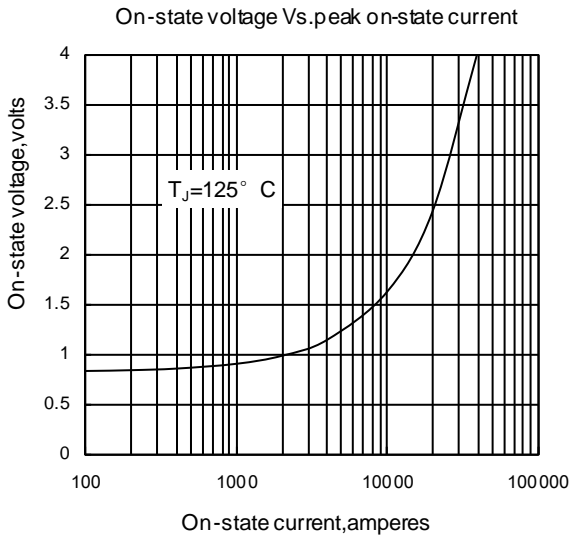

Fig1

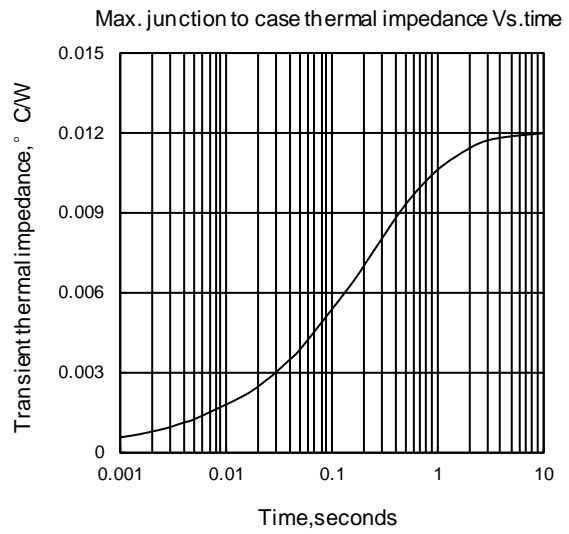

Fig2

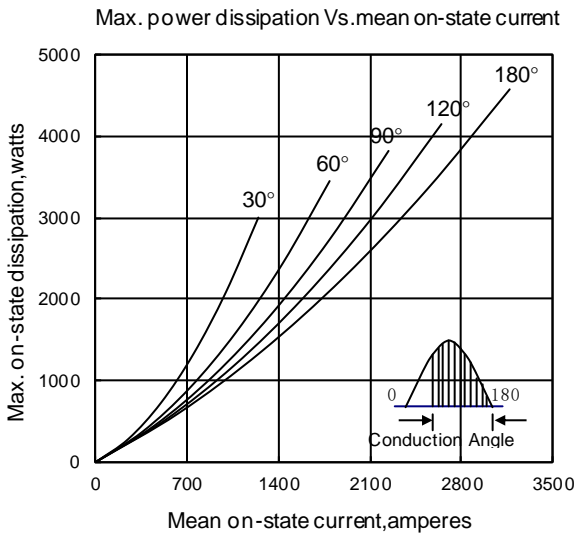

Fig3

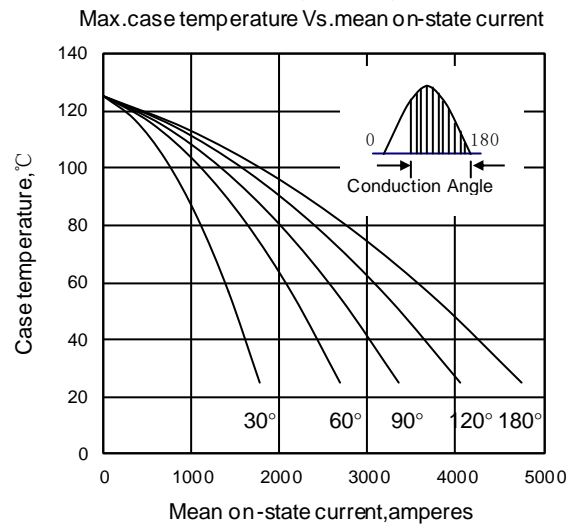

Fig4

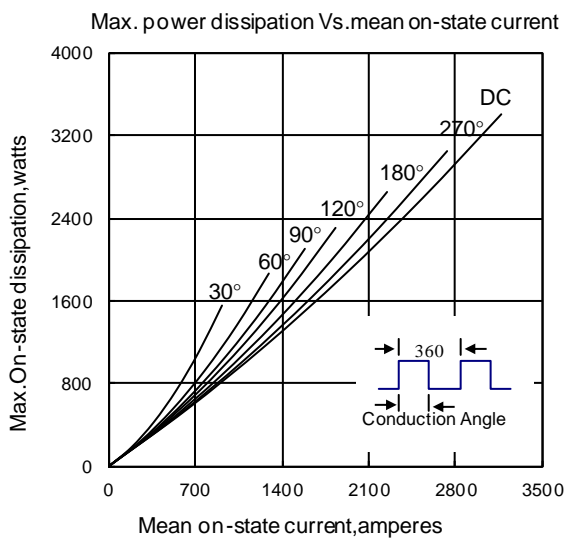

Fig5

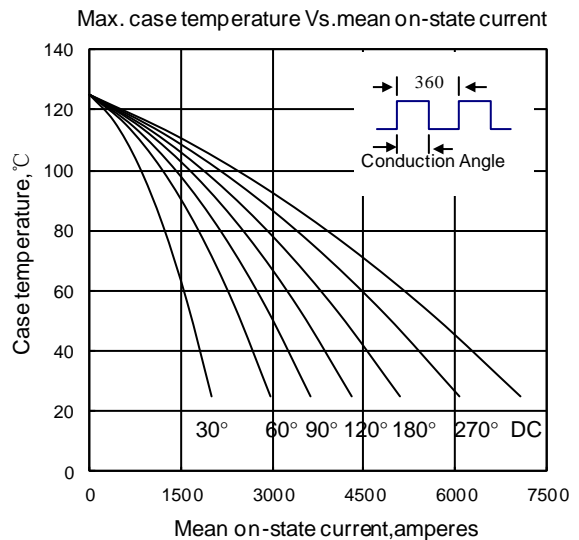

Fig6

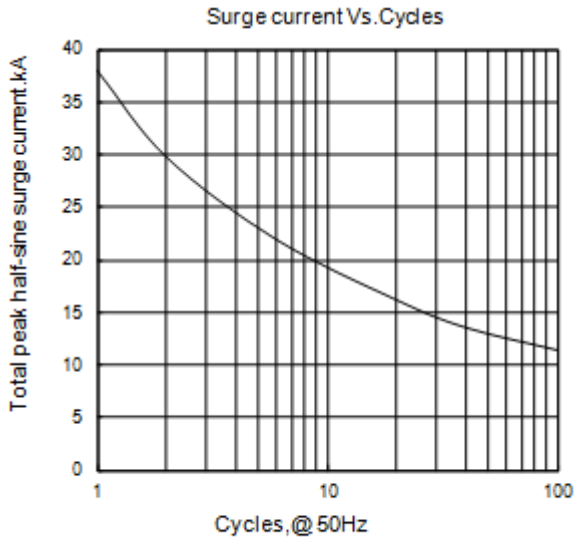

Fig7

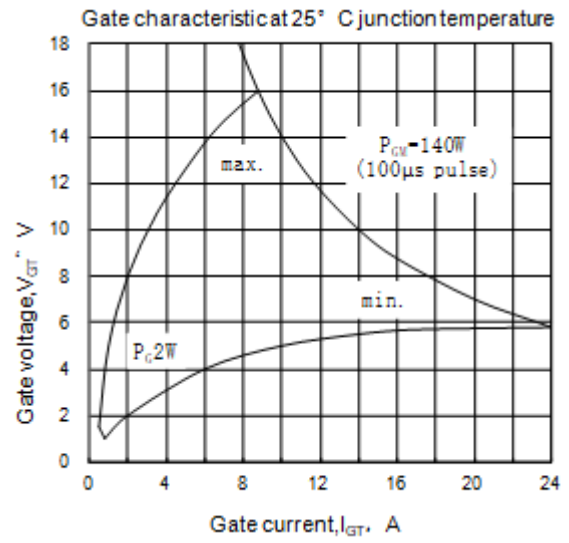

Fig8

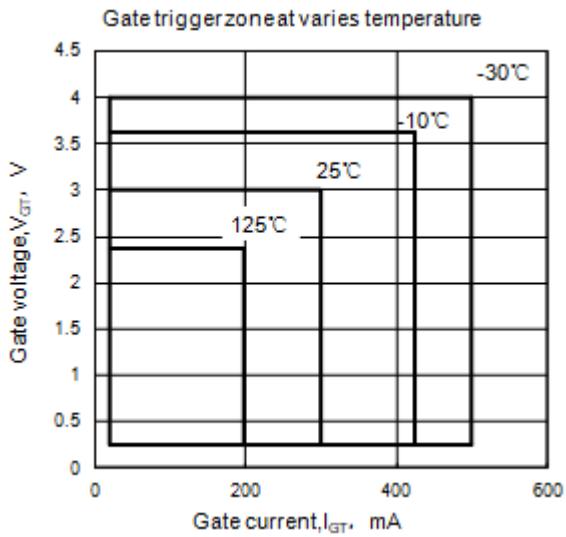
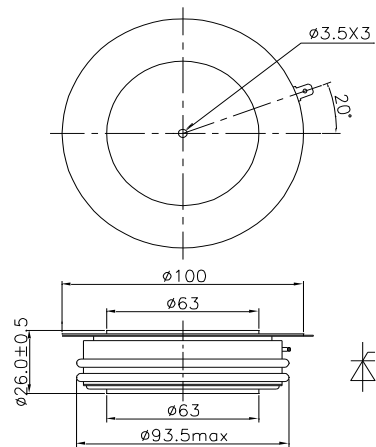

Fig9



Nlps reserves the right to change specifications without notice.