

Features

- Center amplifying gate
- Metal case with ceramic insulator
- Low on-state and switching losses

Typical Applications

- AC controllers
- DC and AC motor control
- Controlled rectifiers

$I_{T(AV)}$	2150A
V_{DRM}/V_{RRM}	200~600V
I_{TSM}	30 kA
I^2t	4500 10³A²S



SYMBOL	CHARACTERISTIC	TEST CONDITIONS	T _j (°C)	VALUE			UNIT	
				Min	Type	Max		
$I_{T(AV)}$	Mean on-state current	180° half sine wave 50Hz Double side cooled	T _C =70°C	125			2150	A
V_{DRM} V_{RRM}	Repetitive peak off-state voltage Repetitive peak reverse voltage	tp=10ms		125	200		600	V
I_{DRM} I_{RRM}	Repetitive peak current	at V_{DRM} at V_{RRM}		125			80	mA
I_{TSM}	Surge on-state current	10ms half sine wave		125			30	kA
I^2t	I^2t for fusing coordination	$V_R=0.6V_{RRM}$					4500	A ² s*10 ³
V_{TO}	Threshold voltage			125			0.75	V
r_r	On-state slope resistance						0.10	mΩ
V_{TM}	Peak on-state voltage	$I_{TM}=3000A, F=24kN$		125			1.05	V
dv/dt	Critical rate of rise of off-state voltage	$V_{DM}=0.67V_{DRM}$		125			1000	V/μs
di/dt	Critical rate of rise of on-state current	$V_{DM}=67\%V_{DRM}$ to 2500A, Gate pulse $t_r \leq 0.5\mu s$ $I_{GM}=1.5A$		125			100	A/μs
Q_{rr}	Recovery charge	$I_{TM}=2000A, tp=2000\mu s, di/dt=-20A/\mu s,$ $V_R=50V$		125		1200		μC
I_{GT}	Gate trigger current				40		300	mA
V_{GT}	Gate trigger voltage	$V_A=12V, I_A=1A$		25	0.8		3.0	V
I_H	Holding current				20		300	mA
V_{GD}	Non-trigger gate voltage	$V_{DM}=67\%V_{DRM}$		125	0.3			V
$R_{th(j-c)}$	Thermal resistance Junction to case	DC: double side cooled					0.020	°C/W
$R_{th(c-h)}$	Thermal resistance case to heatsink	Clamping force 24kN					0.005	
F_m	Mounting force				19		26	kN
T_{stg}	Stored temperature				-40		140	°C
W_t	Weight					290		g
Outline	P05							

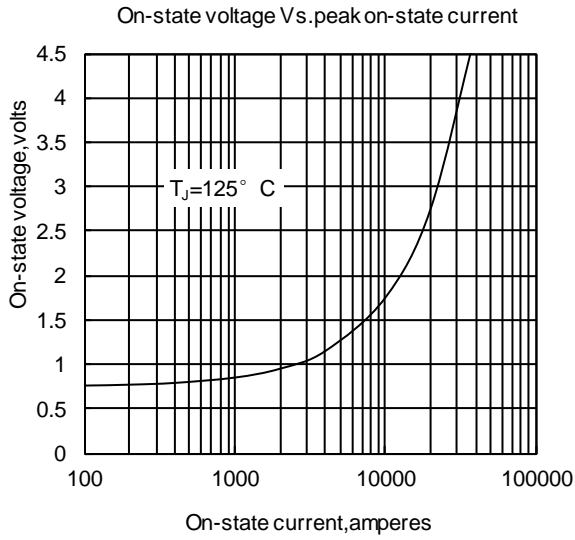

Fig1

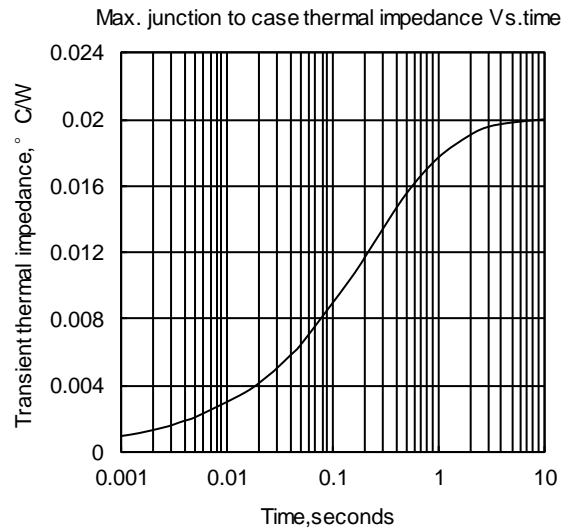

Fig2

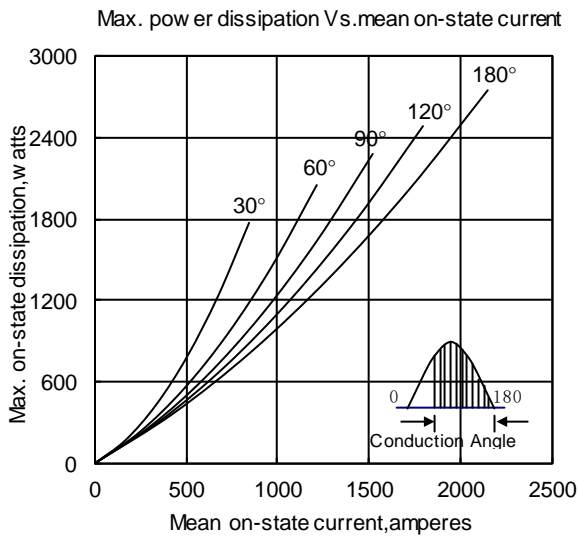

Fig3

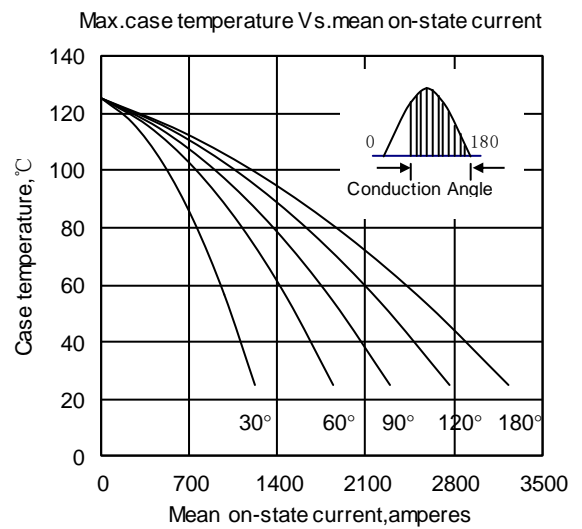

Fig4

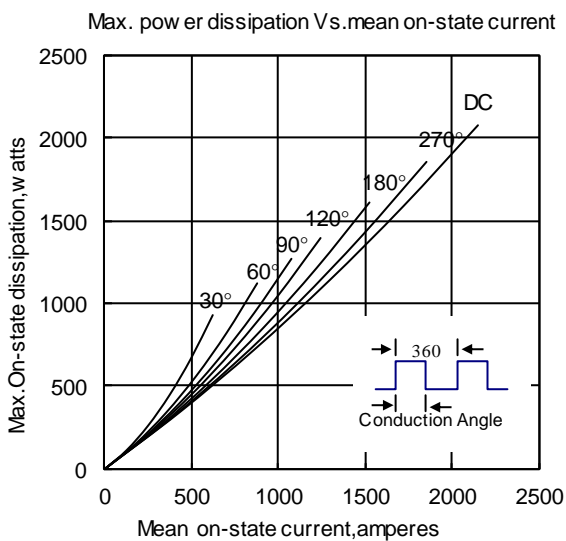

Fig5

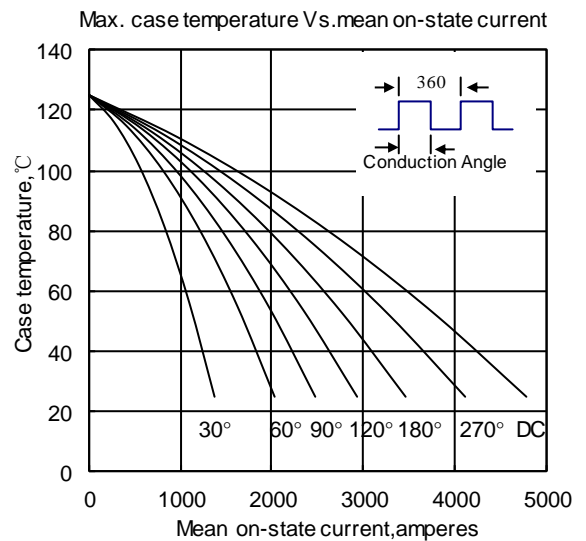

Fig6

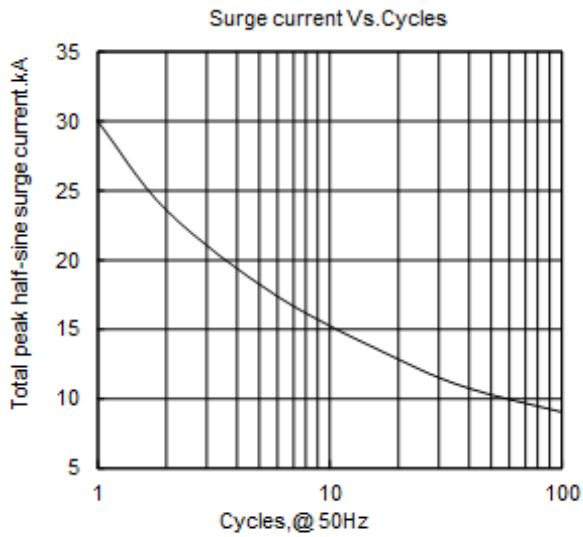

Fig7

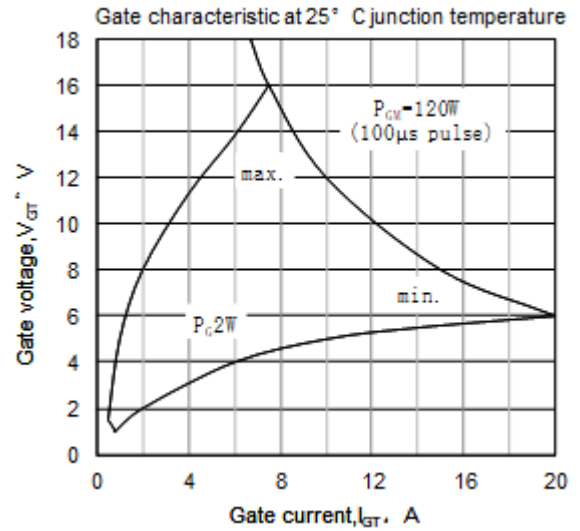

Fig8

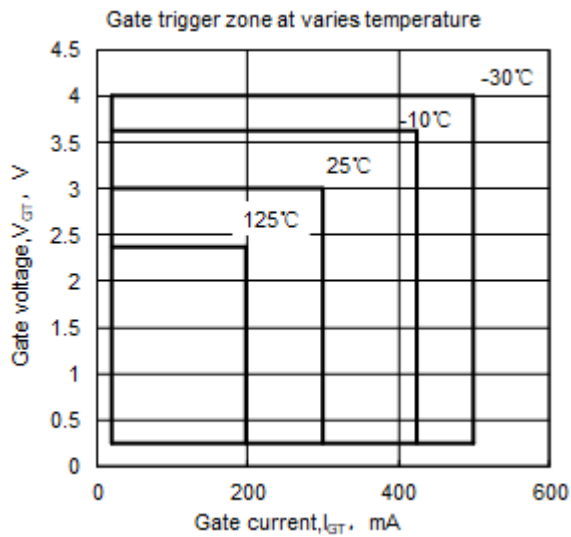
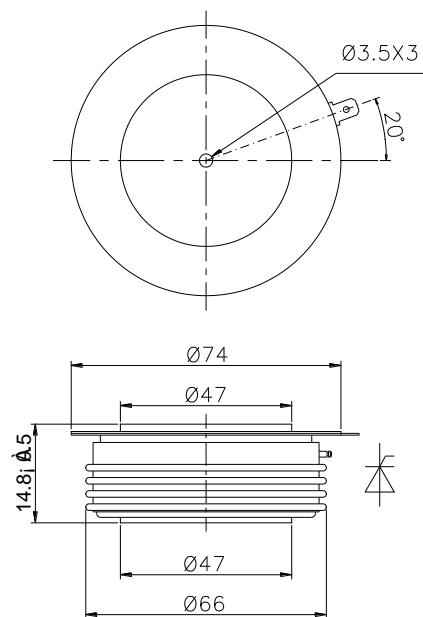

Fig9



Nlps reserves the right to change specifications without notice.