

Features

- Low forward voltage drop
- High reverse voltage
- Hermetic metal cases with ceramic insulators

Typical Applications

- All purpose high power rectifier diodes
- High power resistance welding equipment
- Non-controllable and half-controllable rectifiers
- Controlled rectifiers

$I_{F(AV)}$ 1790 A
 V_{RRM} 1100~2000 V
 I_{FSM} 18 kA
 I^2t 1620 10³A²S



SYMBOL	CHARACTERISTIC	TEST CONDITIONS	T _j (°C)	VALUE			UNIT
				Min	Type	Max	
$I_{F(AV)}$	Mean forward current	180° half sine wave 50Hz Double side cooled, T _c =85°C	175			1790	A
V_{RRM}	Repetitive peak reverse voltage	t _p =10ms	175	1100		2000	V
I_{RRM}	Repetitive peak current	at V_{RRM}	175			50	mA
I_{FSM}	Surge forward current	10ms half sine wave	175			18	kA
I^2t	I^2t for fusing coordination	$V_R=0.6V_{RRM}$				1620	A ² s*10 ³
V_{FO}	Threshold voltage		175			0.90	V
r_F	Forward slope resistance					0.204	mΩ
V_{FM}	Peak forward voltage	$I_{FM}=3000A, F=18kN$	175			1.50	V
Q_{rr}	Recovery charge	$I_{FM}=2000A, t_p=2000\mu s, di/dt=-20A/\mu s, V_R=50V$	175		1900		μC
$R_{th(j-c)}$	Thermal resistance Junction to case	DC: double side cooled Clamping force 18.0kN				0.028	°C /W
$R_{th(c-h)}$	Thermal resistance case to heat sink					0.0075	
F_m	Mounting force			10		20	kN
T_{stg}	Stored temperature			-40		175	°C
W_t	Weight				320		g
Outline	P40						

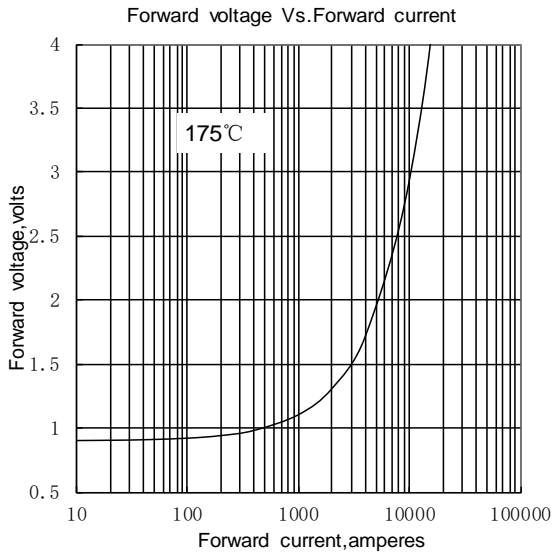

Fig.1

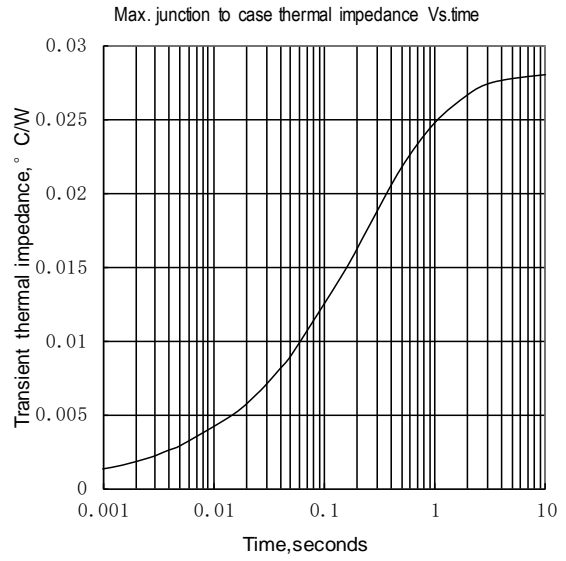

Fig.2

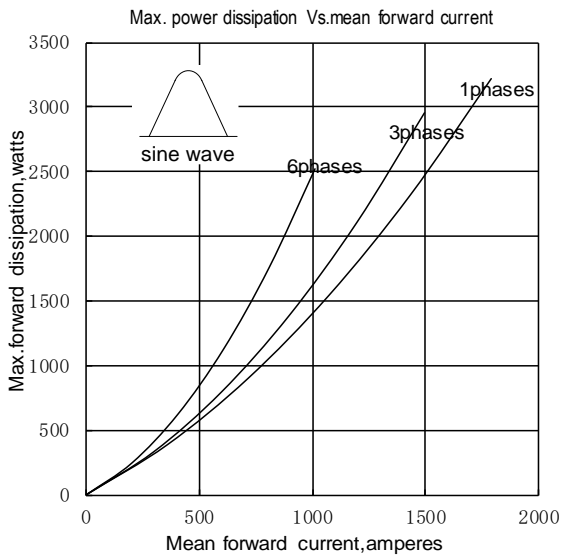

Fig.3

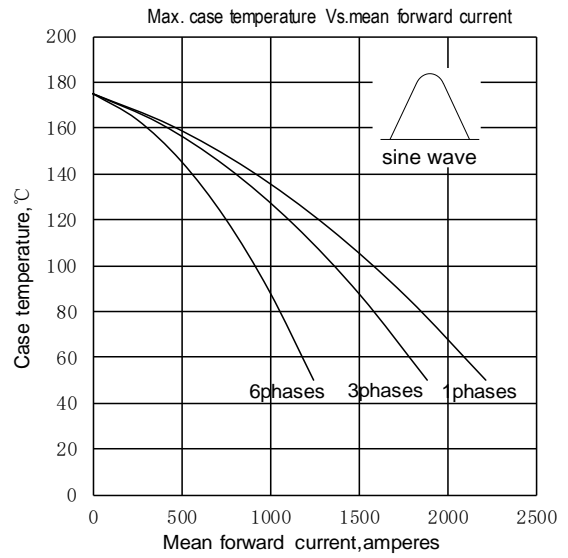

Fig.4

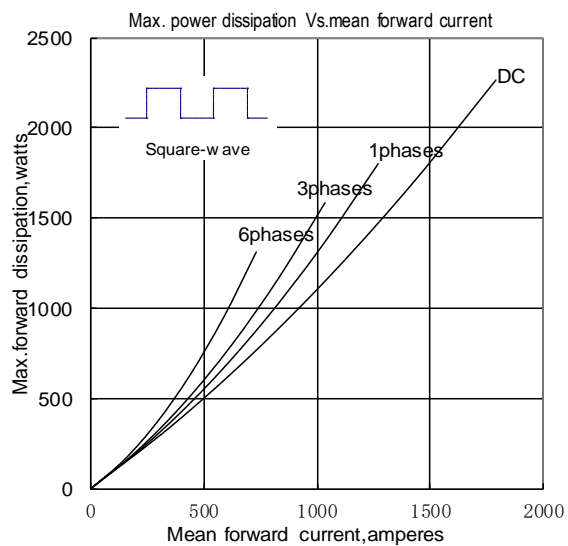

Fig.5

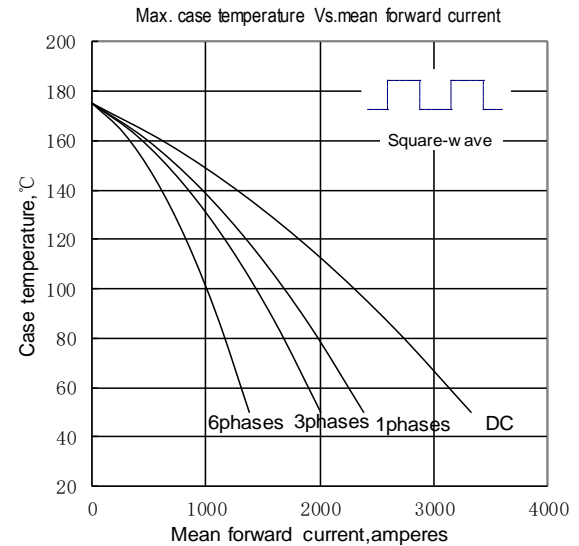

Fig.6

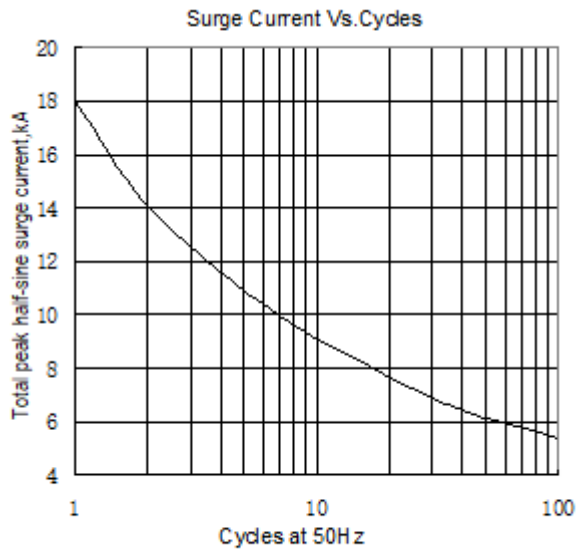
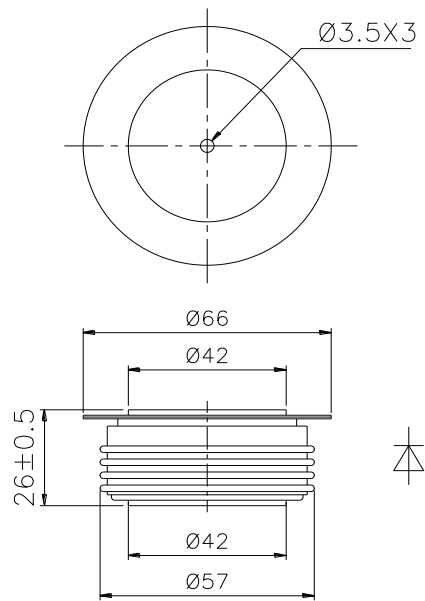

Fig.7



Nlps reserves the right to change specifications without notice.