

Features

- Center amplifying gate
- Metal case with ceramic insulator
- Low on-state and switching losses

$I_{T(AV)}$ 1300A
 V_{DRM}/V_{RRM} 200~600V
 I_{TSM} 18 kA
 I^2t 1620 10³A²S

Typical Applications

- AC controllers
- DC and AC motor control
- Controlled rectifiers



SYMBOL	CHARACTERISTIC	TEST CONDITIONS	T _i (°C)	VALUE			UNIT
				Min	Type	Max	
$I_{T(AV)}$	Mean on-state current	180° half sine wave 50Hz Double side cooled T _c =70°C	125			1300	A
V_{DRM} V_{RRM}	Repetitive peak off-state voltage Repetitive peak reverse voltage	tp=10ms	125	200		600	V
I_{DRM} I_{RRM}	Repetitive peak current	at V_{DRM} at V_{RRM}	125			40	mA
I_{TSM}	Surge on-state current	10ms half sine wave	125			18	kA
I^2t	I^2t for fusing coordination	$V_R=0.6V_{RRM}$				1620	A ² s*10 ³
V_{TO}	Threshold voltage		125			0.76	V
r_T	On-state slope resistance					0.14	mΩ
V_{TM}	Peak on-state voltage	$I_{TM}=2000A, F=15kN$	125			1.10	V
dv/dt	Critical rate of rise of off-state voltage	$V_{DM}=0.67V_{DRM}$	125			1000	V/μs
di/dt	Critical rate of rise of on-state current	$V_{DM}= 67\%V_{DRM}$ to 1300A, Gate pulse $t_r \leq 0.5\mu s$ $I_{GM}=1.5A$	125			100	A/μs
Q_{rr}	Recovery charge	$I_{TM}=1500A, tp=2000\mu s, di/dt=-20A/\mu s,$ $V_R =50V$	125		1000		μC
I_{GT}	Gate trigger current	$V_A=12V, I_A=1A$	25	35		300	mA
V_{GT}	Gate trigger voltage			0.8		2.5	V
I_H	Holding current			20		250	mA
V_{GD}	Non-trigger gate voltage	$V_{DM}=0.67V_{DRM}$	125	0.3			V
$R_{th(j-c)}$	Thermal resistance Junction to case	DC: double side cooled Clamping force 15kN				0.035	°C/W
$R_{th(c-h)}$	Thermal resistance case to heatsink					0.008	
F_m	Mounting force			10		20	kN
T_{sig}	Stored temperature			-40		140	°C
W_t	Weight				150		g
Outline	P04						

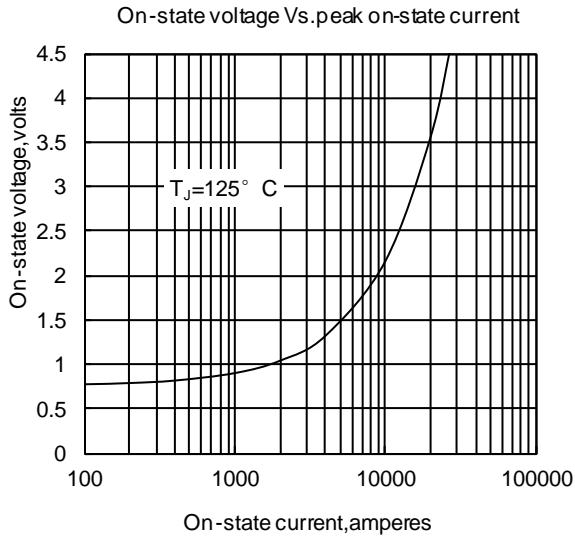

Fig1

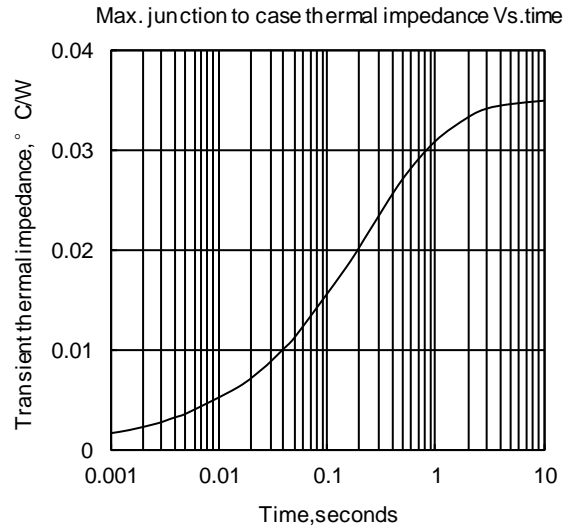

Fig2

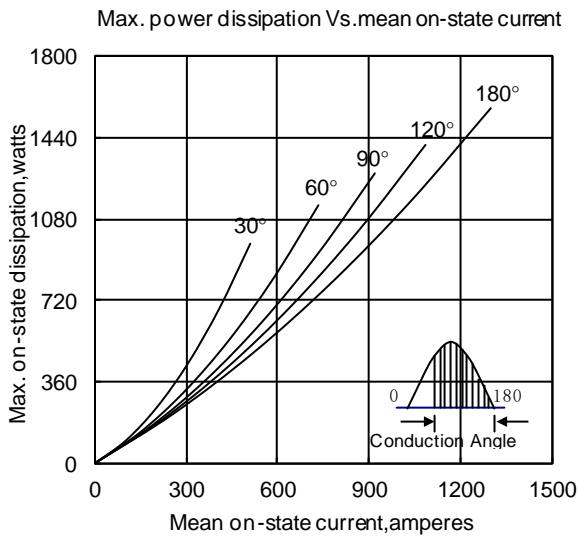

Fig3

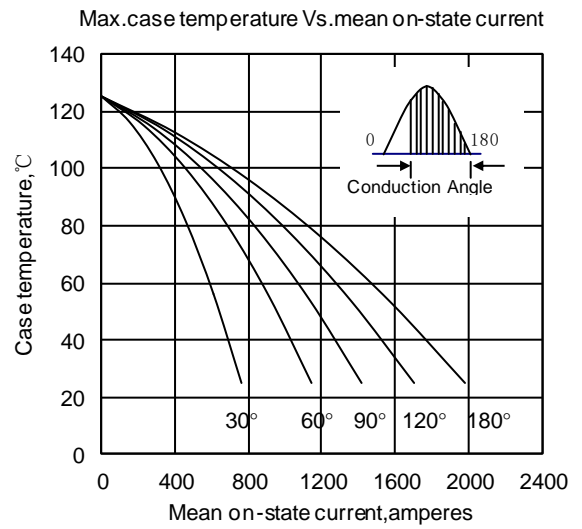

Fig4

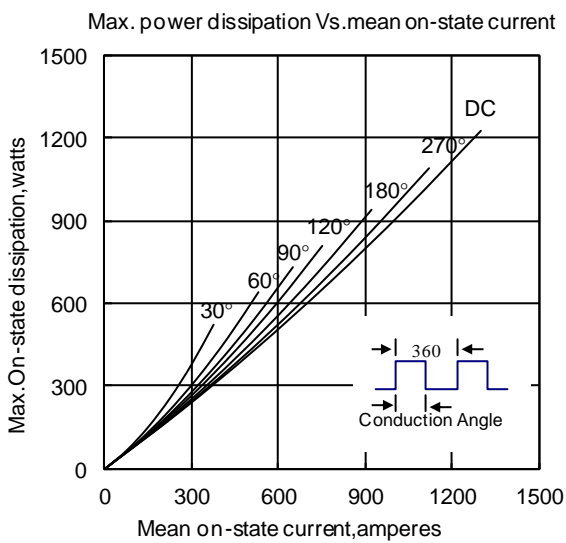

Fig5

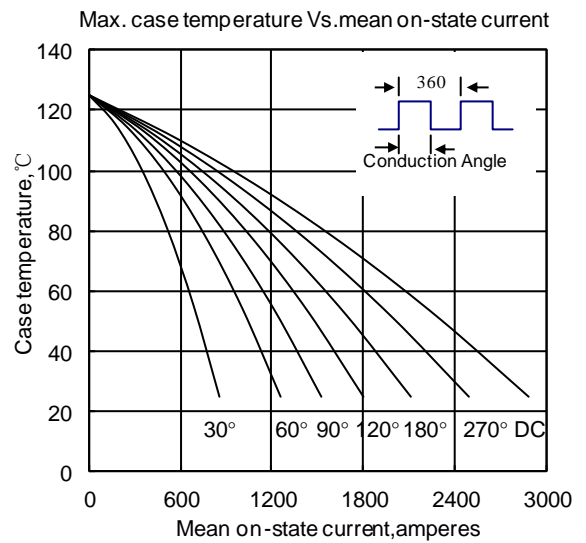

Fig6

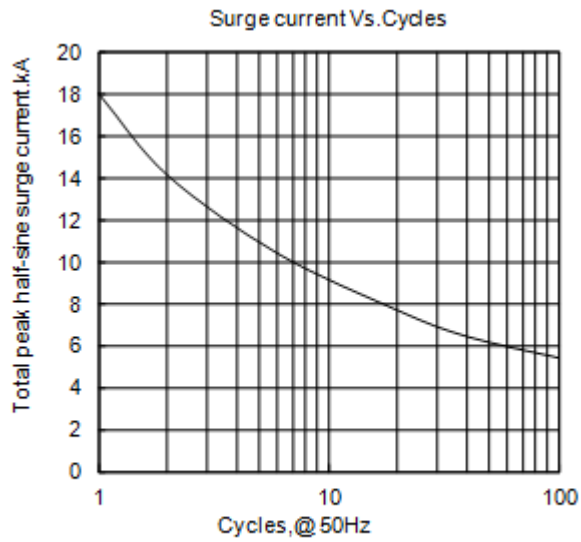

Fig7

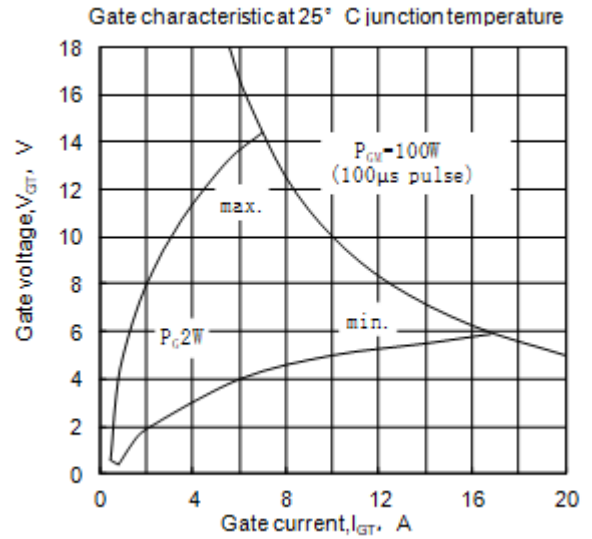

Fig8

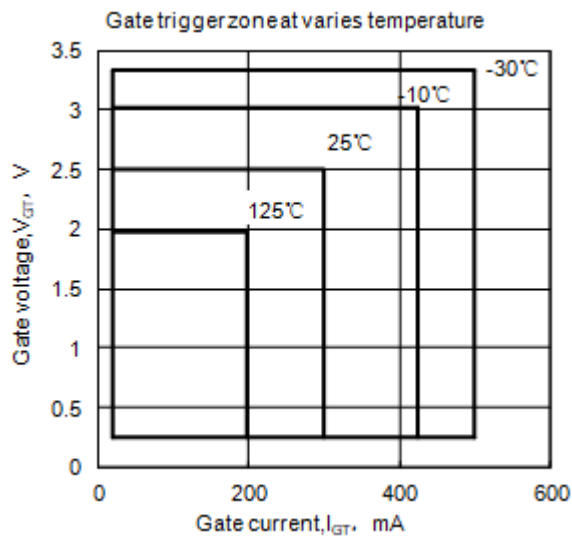
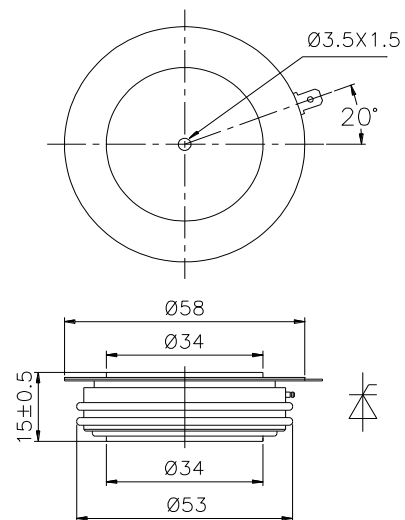

Fig9



Nlps reserves the right to change specifications without notice.