

Features :

- Isolated mounting base 3000V~
- Pressure contact technology with Increased power cycling capability
- Space and weight saving

V _{DSM} , V _{RSM}	V _{DRM} , V _{RRM}	品名
2100V	2000V	Mx300T200
2300V	2200V	Mx300T220
2600V	2500V	Mx300T250

Typical Applications :

- AC/DC Motor drives
- Various rectifiers
- DC supply for PWM inverter

SYMBOL	CHARACTERISTIC	TEST CONDITIONS	T _j (°C)	VALUE			UNIT
				Min	Type	Max	
I _{T(AV)}	Mean on-state current	180° half sine wave 50Hz Single side cooled, T _C =85°C	125			300	A
I _{T(RMS)}	RMS on-state current					471	A
I _{DRM} I _{RRM}	Repetitive peak current	at V _{DRM} at V _{RRM}	125			35	mA
I _{TSM}	Surge on-state current	V _R =60%V _{RRM} , t=10ms half sine,	125			8	kA
I ² t	I ² t for fusing coordination		125			320	10 ³ A ² s
V _{TO}	Threshold voltage		125			0.85	V
r _T	On-state slope resistance					0.65	mΩ
V _{TM}	Peak on-state voltage	I _{TM} =900A	25			1.99	V
dv/dt	Critical rate of rise of off-state voltage	V _{DM} =67%V _{DRM}	125			1000	V/μs
di/dt	Critical rate of rise of on-state current	Gate source 1.5A t _r ≤ 0.5μs Repetitive	125			200	A/μs
I _{GT}	Gate trigger current	V _A =12V, I _A =1A	25	30		200	mA
V _{GT}	Gate trigger voltage			0.7		2.5	V
I _H	Holding current			10		200	mA
I _L	Latching current					1000	mA
V _{GD}	Non-trigger gate voltage	V _{DM} =67%V _{DRM}	125			0.20	V
R _{th(j-c)}	Thermal resistance Junction to case	D.C. Single side cooled per chip				0.10	°C/W
R _{th(c-h)}	Thermal resistance case to heatsink	D.C. Single side cooled per chip				0.04	°C/W
V _{iso}	Isolation voltage	50Hz, R.M.S, t=1min, I _{iso} : 1mA(MAX)		3000			V
F _m	Terminal connection torque(M8)			10		12	N·m
	Mounting torque(M6)			4.5		6	N·m
T _{vj}	Junction temperature			-40		125	°C
T _{stg}	Stored temperature			-40		125	°C
W _t	Weight				770		g
Outline	M03						

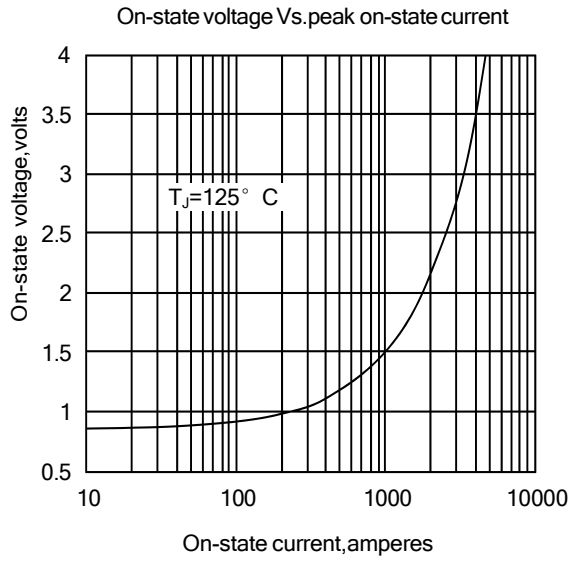

Fig. 1

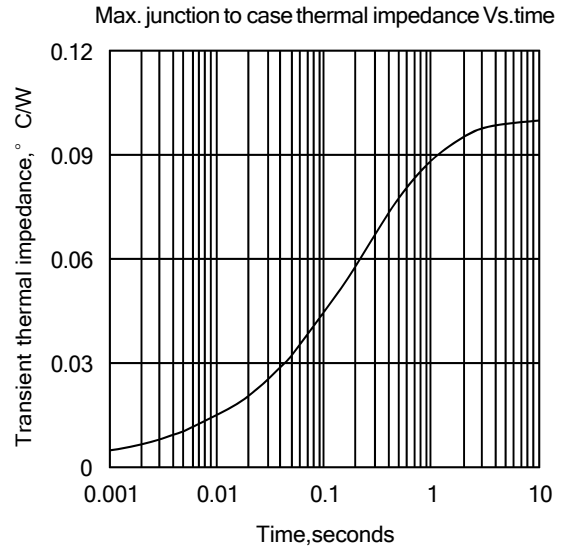

Fig. 2

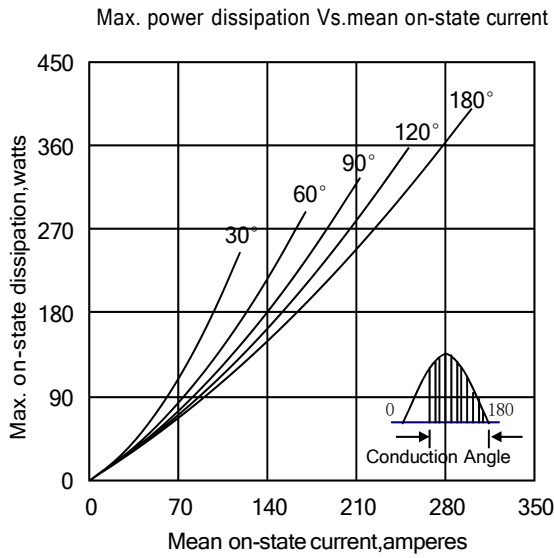

Fig. 3

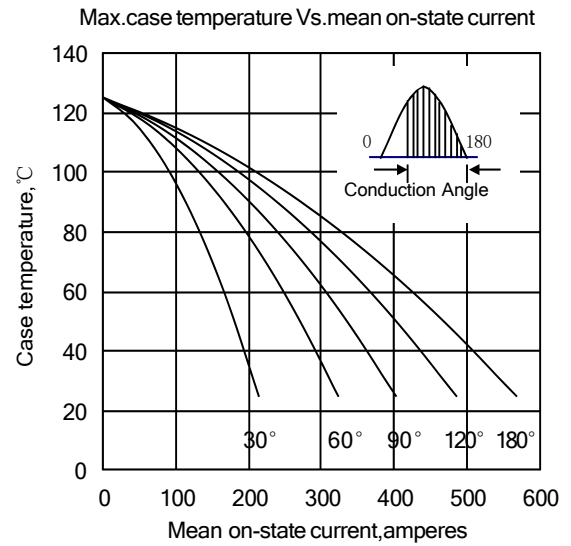

Fig. 4

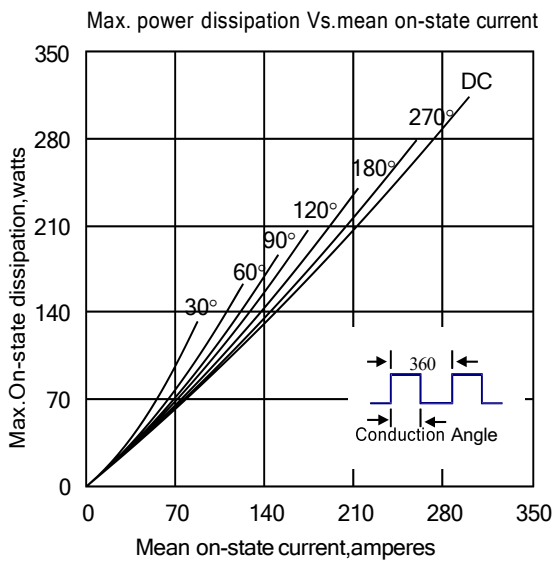

Fig. 5

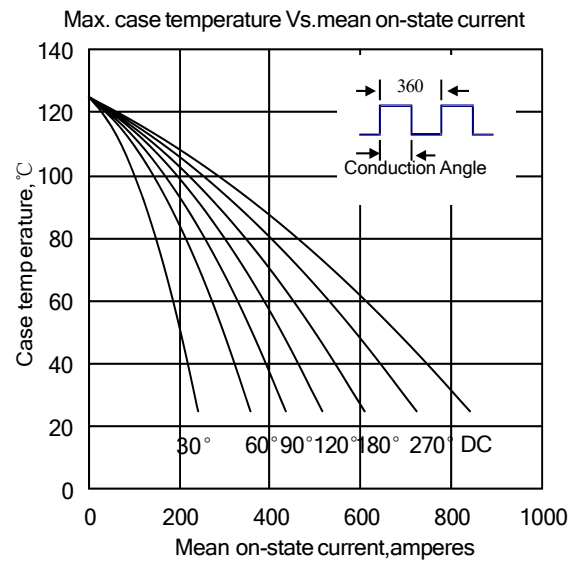

Fig. 6

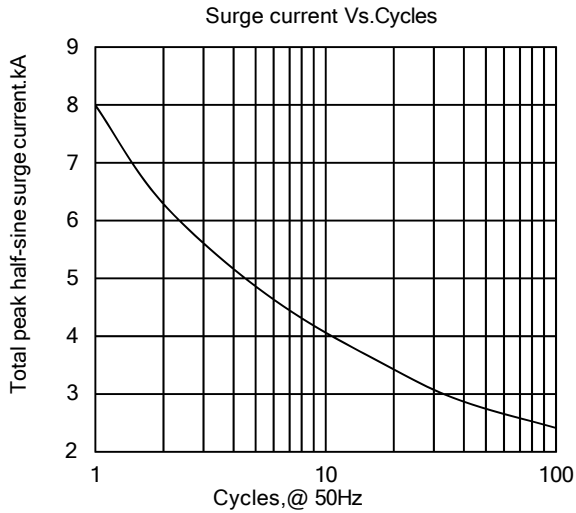

Fig. 7

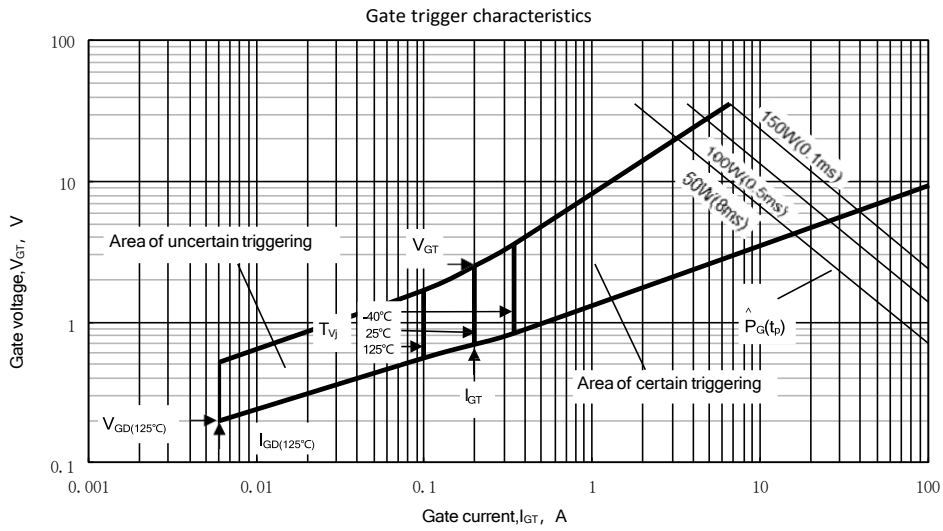
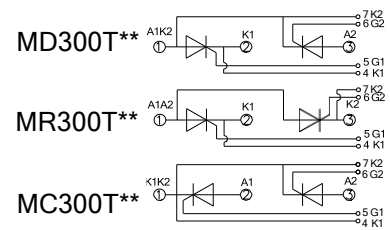
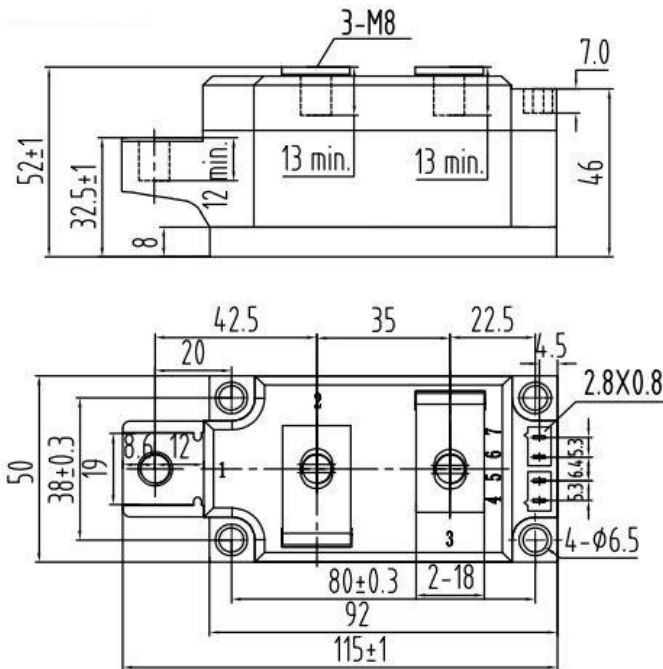

Fig. 8

Outline:



Unmarked dimensional tolerance: $\pm 0.5\text{mm}$

NIPS reserves the right to change specifications without notice.