

Features :

- Isolated mounting base 3000V~
- Pressure contact technology with
Increased power cycling capability
- Space and weight saving

Typical Applications

- AC/DC Motor drives
- Various rectifiers
- DC supply for PWM inverter

V_{DSM}, V_{RSM}	V_{DRM}, V_{RRM}	品名
900V	800V	Mx182TH80
1100V	1000V	Mx182TH100
1300V	1200V	Mx182TH120
1500V	1400V	Mx182TH140
1700V	1600V	Mx182TH160
1900V	1800V	Mx182TH180

SYMBOL	CHARACTERISTIC	TEST CONDITIONS	$T_j(^{\circ}\text{C})$	VALUE			UNIT
				Min.	Typ.	Max.	
$I_{T(AV)}$	Mean on-state current	180° half sine wave 50Hz Single side cooled, $T_c=85^{\circ}\text{C}$	125			182	A
$I_{T(RMS)}$	RMS on-state current					286	A
I_{DRM} I_{RRM}	Repetitive peak current	at V_{DRM} at V_{RRM}	125			20	mA
I_{TSM}	Surge on-state current	10ms half sine wave $V_R=60\%V_{RRM}$	125			5.4	kA
I^2t	I^2t for fusing coordination					145.8	$\text{A}^2\text{s}\cdot 10^3$
V_{TO}	Threshold voltage		125			0.80	V
r_T	On-state slope resistance					1.26	$\text{m}\Omega$
V_{TM}	Peak on-state voltage	$I_{TM}=550\text{A}$	25			1.62	V
dv/dt	Critical rate of rise of off-state voltage	$V_{DM}=67\%V_{DRM}$	125			1000	$\text{V}/\mu\text{s}$
di/dt	Critical rate of rise of on-state current	Gate source 1.5A $t_r \leq 0.5\mu\text{s}$ Repetitive	125			200	$\text{A}/\mu\text{s}$
I_{GT}	Gate trigger current	$V_A=12\text{V}, I_A=1\text{A}$	25	30		150	mA
V_{GT}	Gate trigger voltage			0.8		2.5	V
I_H	Holding current			10		120	mA
V_{GD}	Non-trigger gate voltage	$V_{DM}=67\%V_{DRM}$	125	0.2			V
$R_{th(j-c)}$	Thermal resistance Junction to case	D.C. Single side cooled per chip				0.16	$^{\circ}\text{C}/\text{W}$
$R_{th(c-h)}$	Thermal resistance case to heatsink	D.C. Single side cooled per chip				0.08	$^{\circ}\text{C}/\text{W}$
V_{iso}	Isolation voltage	50Hz, R.M.S, $t=1\text{min}, I_{iso}: 1\text{mA}(\text{MAX})$		3000			V
F_m	Terminal connection torque(M6)			3.5		5.0	N·m
	Mounting torque(M6)				6.0		N·m
T_{vj}	Junction temperature			-40		125	$^{\circ}\text{C}$
T_{stg}	Stored temperature			-40		125	$^{\circ}\text{C}$
W_t	Weight				320		g
Outline	M02						

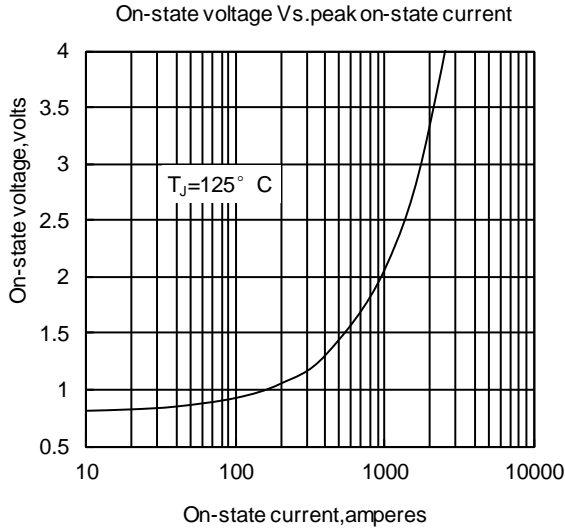

Fig1

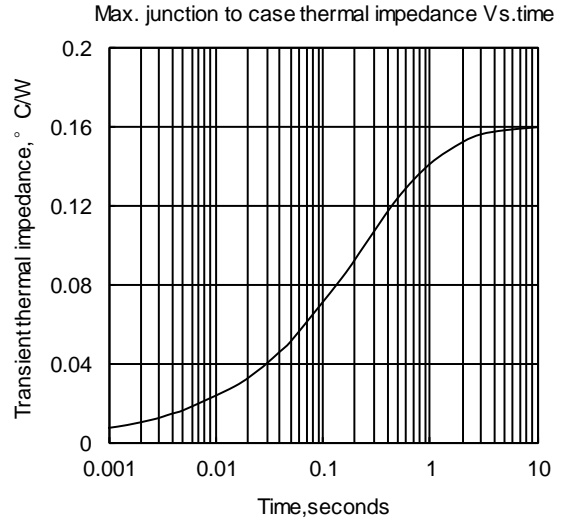

Fig2

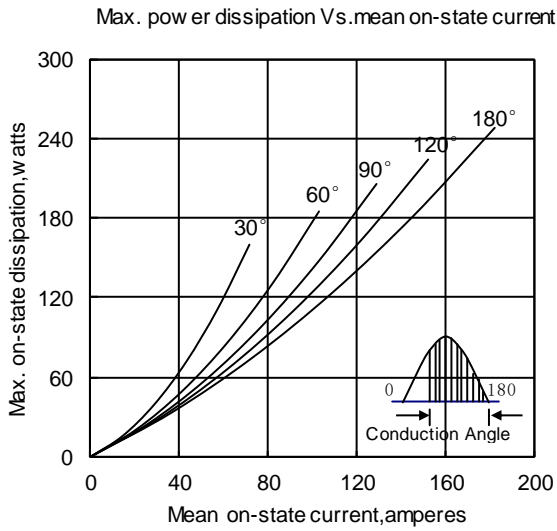

Fig3

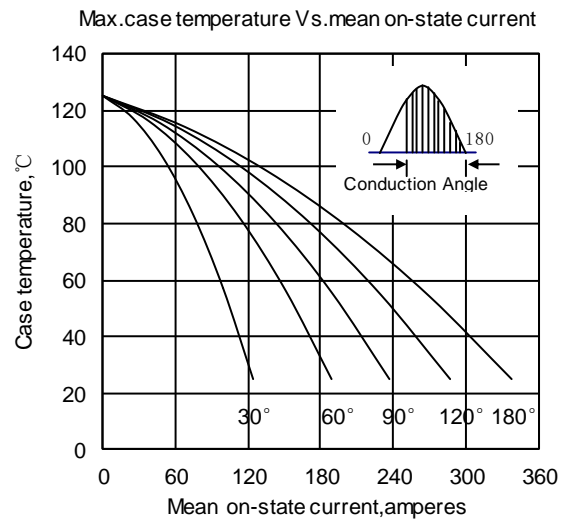

Fig4

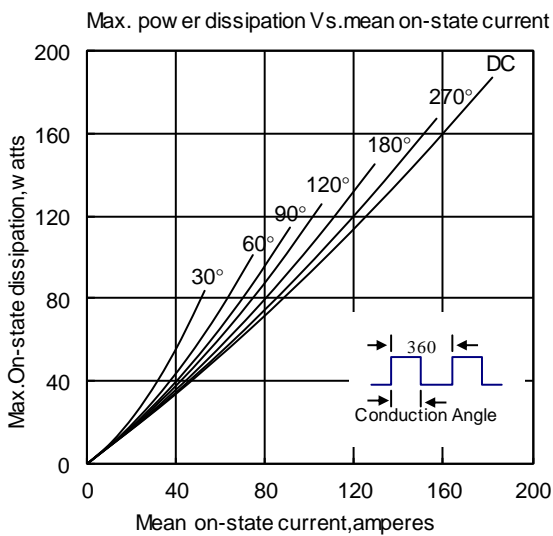

Fig5

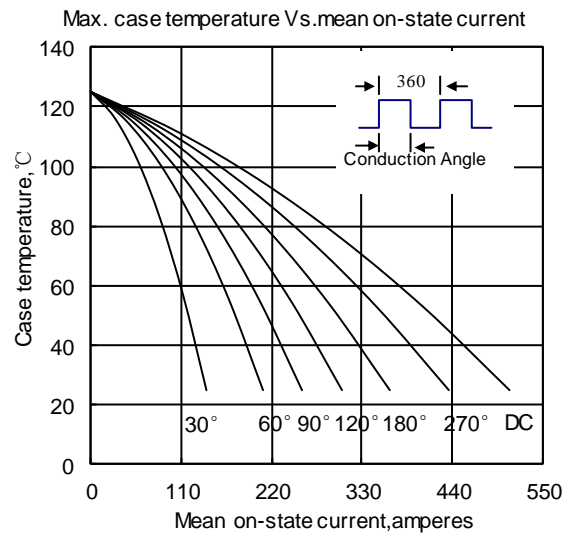

Fig6

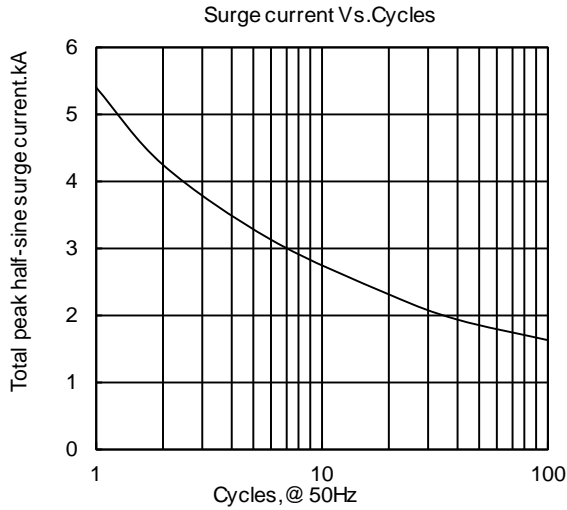

Fig7

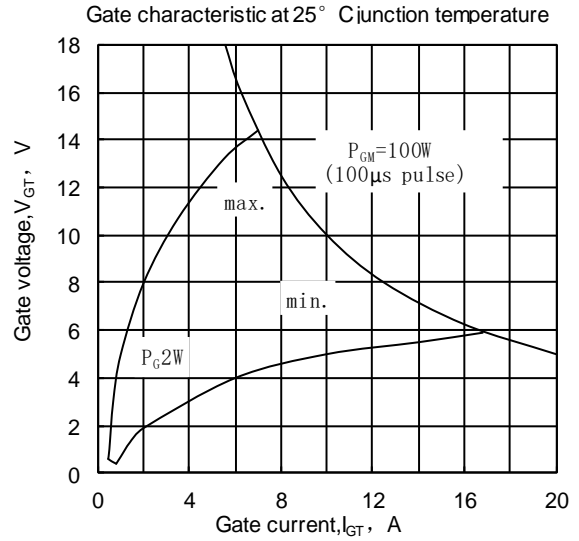

Fig8

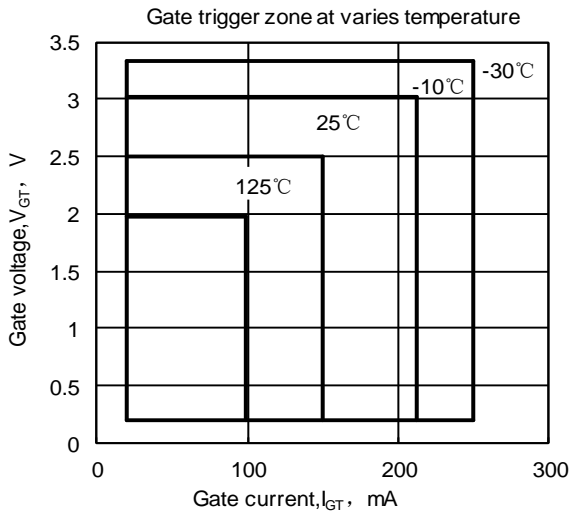
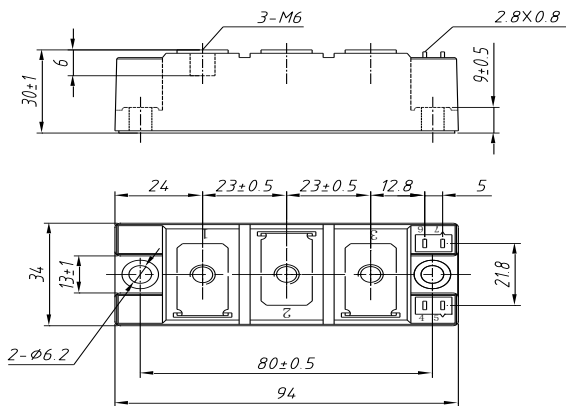
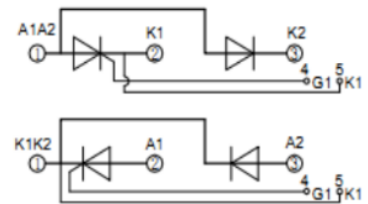

Fig9



MR182TH**

MC182TH**



Unmarked dimensional tolerance : ±0.5mm