

Features :

- Isolated mounting base 2500V~
- Pressure contact technology with Increased power cycling capability
- Space and weight saving

Typical Applications

- Inverter
- Inductive heating
- Chopper

V_{RSM}	V_{RRM}	Type
900V	800V	Mx75DF80
1100V	1000V	Mx75DF100
1300V	1200V	Mx75DF120
1500V	1400V	Mx75DF140
1700V	1600V	Mx75DF160
1900V	1800V	Mx75DF180

SYMBOL	CHARACTERISTIC	TEST CONDITIONS	T_j (°C)	VALUE			UNIT
				Min	Type	Max	
$I_{F(AV)}$	Mean forward current	180° half sine wave 50Hz Single side cooled, $T_C=100^\circ\text{C}$	150			75	A
$I_{F(RMS)}$	RMS forward current					118	A
I_{RRM}	Repetitive peak current	at V_{RRM}	150			20	mA
I_{FSM}	Surge forward current	10ms half sine wave $V_R=0.6V_{RRM}$	150			2.0	kA
I^2t	I^2t for fusing coordination					20	$\text{A}^2\text{s}\cdot 10^3$
V_{FO}	Threshold voltage		150			1.10	V
r_F	Forward slope resistance					3.00	$\text{m}\Omega$
V_{FM}	Peak forward voltage	$I_{FM}=225\text{A}$	25			2.00	V
t_{rr}	Reverse recovery time	$I_{FM}=200\text{A}$, $t_p=2000\mu\text{s}$, $-di/dt=20\text{A}/\mu\text{s}$, $V_R=50\text{V}$	150			4.0	μs
$R_{th(j-c)}$	Thermal resistance Junction to case	Single side cooled per chip				0.310	$^\circ\text{C}/\text{W}$
$R_{th(c-h)}$	Thermal resistance case to heatsink	Single side cooled per chip				0.080	$^\circ\text{C}/\text{W}$
F_m	Terminal connection torque(M6)				6.0		N·m
	Mounting torque(M6)				6.0		N·m
V_{iso}	Isolation voltage	50Hz, R.M.S., $t=1\text{min}$, $I_{iso}: 1\text{mA}(\text{MAX})$		2500			V
T_{vj}	Junction temperature			-40		140	$^\circ\text{C}$
T_{stg}	Stored temperature			-40		125	$^\circ\text{C}$
W_t	Weight				320		g
Outline	M02						

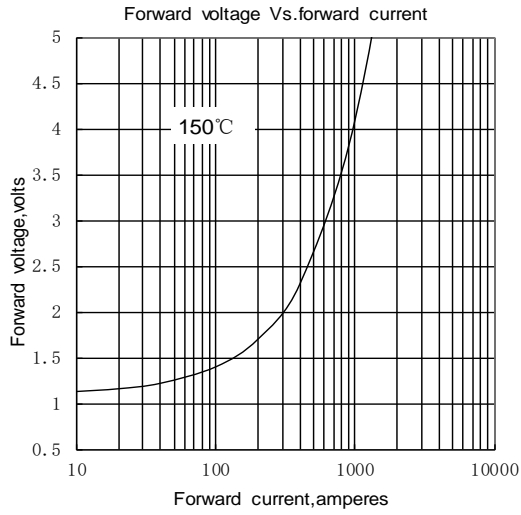

Fig.1

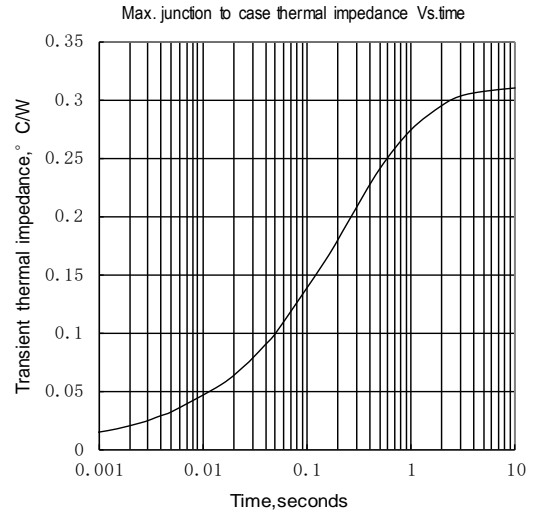

Fig.2

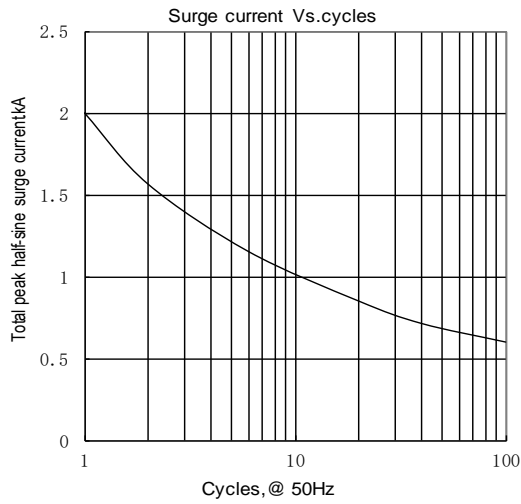

Fig.3

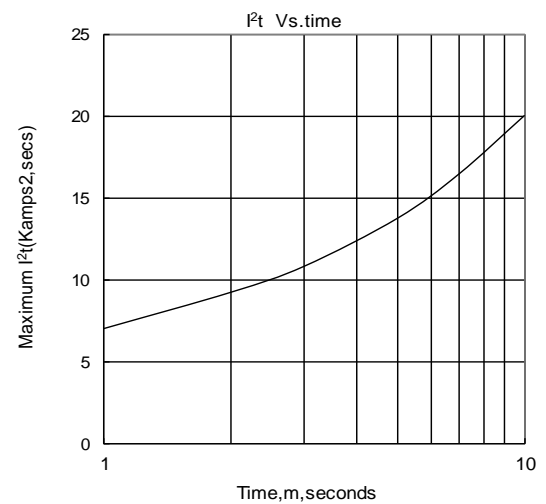
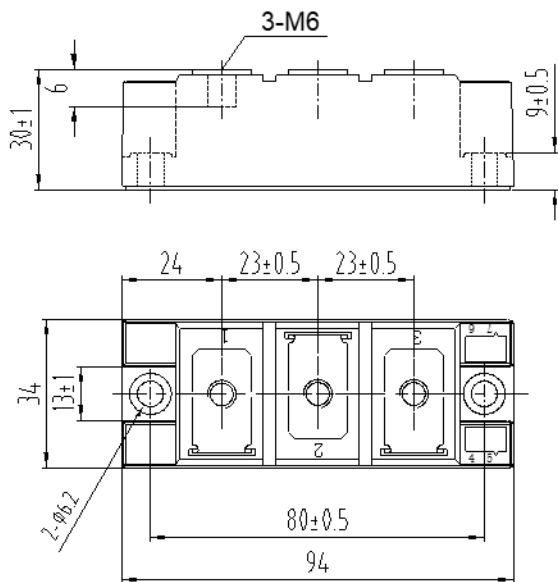
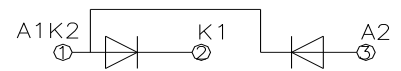

Fig.4

Outline:



MD75DF



MR75DF

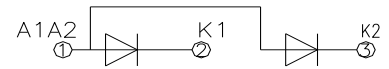

MC75DF

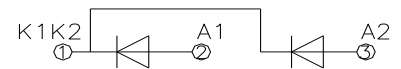

MH75DF

