

Features :

- Isolated mounting base 3000V~
- Solder joint technology with increased power cycling capability
- Space and weight saving

Typical Applications

- Various rectifiers
- DC supply for PWM inverter

V_{RSM}	V_{RRM}	Type
900V	800V	Mx70D80S
1100V	1000V	Mx70D100S
1300V	1200V	Mx70D120S
1500V	1400V	Mx70D140S
1700V	1600V	Mx70D160S
1900V	1800V	Mx70D180S

SYMBOL	CHARACTERISTIC	TEST CONDITIONS	$T_j(^{\circ}C)$	VALUE			UNIT
				Min	Type	Max	
$I_{F(AV)}$	Mean forward current	180° half sine wave 50Hz Single side cooled, $T_c=100^{\circ}C$	150			70	A
$I_{F(RMS)}$	RMS forward current		150			110	A
I_{RRM}	Repetitive peak current	at V_{RRM}	150			8	mA
I_{FSM}	Surge forward current	10ms half sine wave $V_R=0.6V_{RRM}$	150			1.9	kA
I^2t	I^2t for fusing coordination					18.1	$A^2s \cdot 10^3$
V_{FO}	Threshold voltage		150			0.80	V
r_F	Forward slope resistance					2.50	m Ω
V_{FM}	Peak forward voltage	$I_{FM}=210A$	25			1.45	V
$R_{th(j-c)}$	Thermal resistance Junction to case	Single side cooled per chip				0.57	$^{\circ}C/W$
$R_{th(c-h)}$	Thermal resistance case to heatsink	Single side cooled per chip				0.20	$^{\circ}C/W$
V_{iso}	Isolation voltage	50Hz, R.M.S, $t=1min$, $I_{iso}:1mA(max)$		3000			V
F_m	Terminal connection torque(M5)				4		N·m
	Mounting torque(M6)				6		N·m
T_{stg}	Stored temperature			-40		125	$^{\circ}C$
W_t	Weight				95		g
Outline	M16						

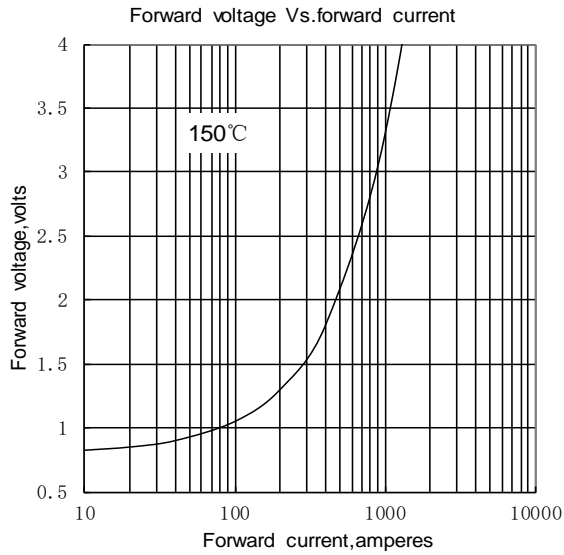

Fig1

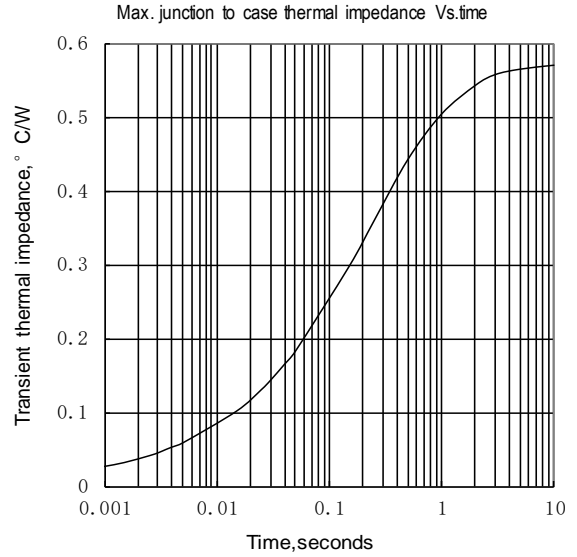

Fig2

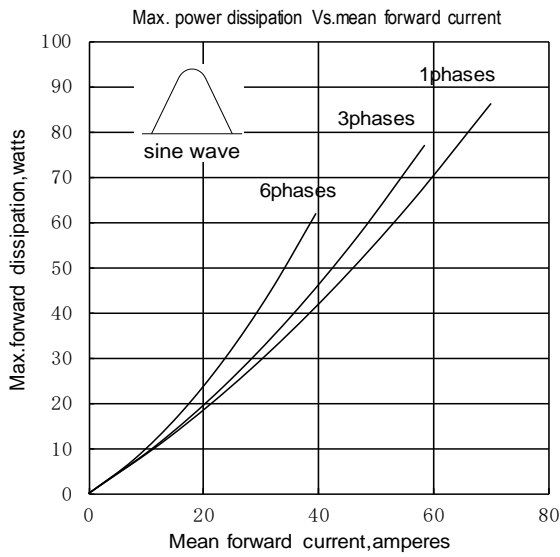

Fig3

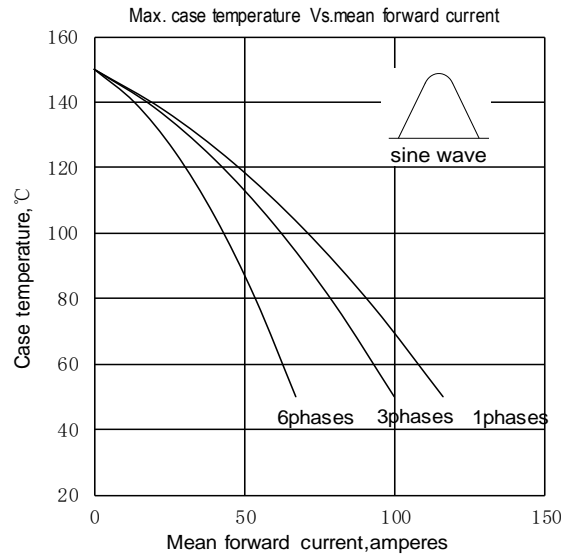

Fig4

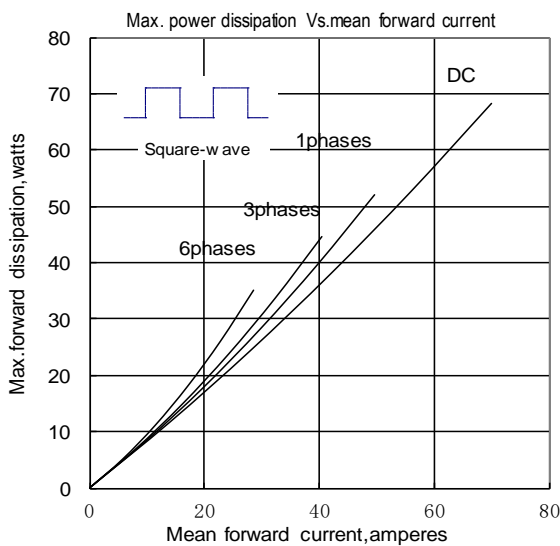

Fig5

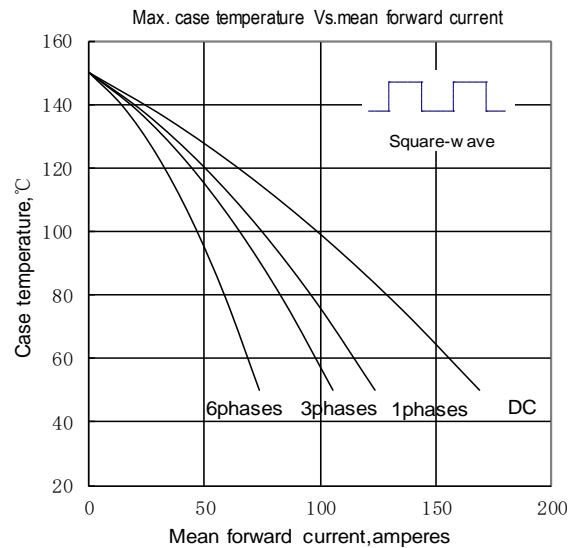

Fig6

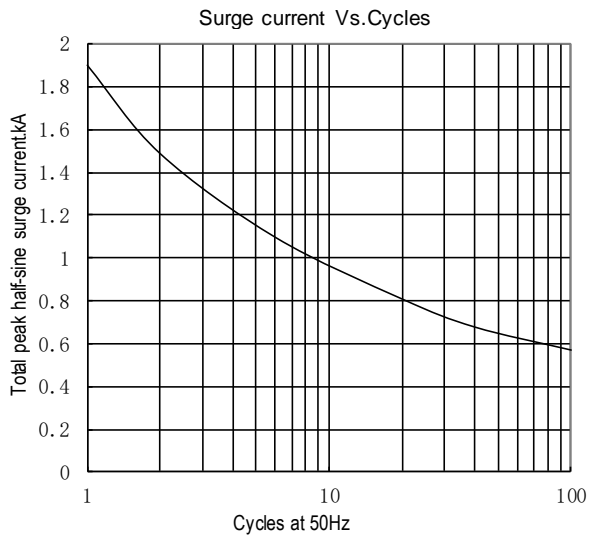

Fig.7

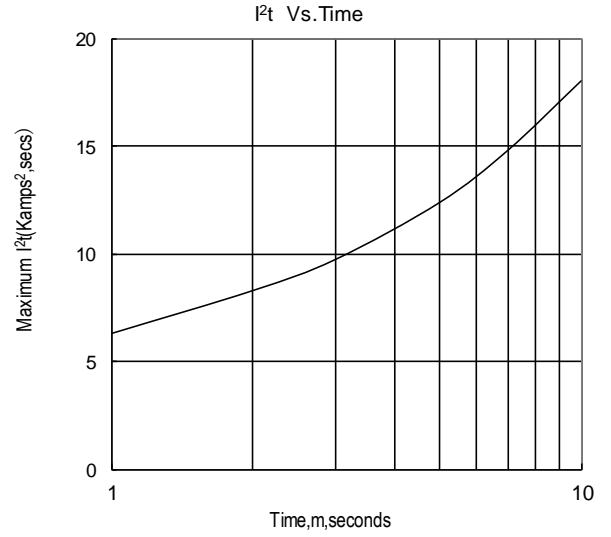
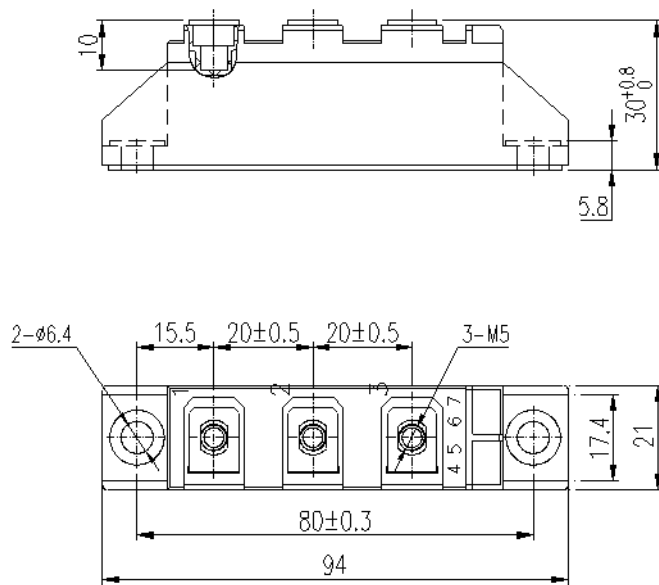
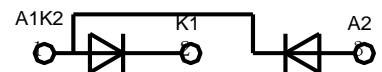

Fig.8

Outline:



MD70D*S



MH70D*S

