

Features:

- Isolated mounting base 3000V~
- Pressure contact technology with Increased power cycling capability
- Space and weight saving

Typical Applications

- AC/DC Motor drives
- DC supply for PWM inverter

V _{RSM}	V _{RRM}	Type
900V	800V	Mx70D80
1100V	1000V	Mx70D100
1300V	1200V	Mx70D120
1500V	1400V	Mx70D140
1700V	1600V	Mx70D160
1900V	1800V	Mx70D180

SYMBOL	CHARACTERISTIC	TEST CONDITIONS	T _j (°C)	VALUE			UNIT
				Min	Type	Max	
I _{F(AV)}	Mean forward current	180° half sine wave 50Hz Single side cooled, T _C =100°C	150			70	A
I _{F(RMS)}	RMS forward current		150			110	A
I _{RRM}	Repetitive peak current	at V _{RRM}	150			8	mA
I _{FSM}	Surge forward current	10ms half sine wave V _R =0.6V _{RRM}	150			1.80	kA
I ² t	I ² t for fusing coordination					16.2	A ² s*10 ³
V _{FO}	Threshold voltage		150			0.80	V
r _F	Forward slope resistance					2.50	mΩ
V _{FM}	Peak forward voltage	I _{FM} =210A	25			1.33	V
R _{th(j-c)}	Thermal resistance Junction to case	At 180° sine Single side cooled per chip				0.57	°C/W
R _{th(c-h)}	Thermal resistance case to heatsink	At 180°sine Single side cooled per chip				0.20	°C/W
V _{iso}	Isolation voltage	50Hz,R.M.S,t=1min,I _{iso} :1mA(max)		3000			V
F _m	Terminal connection torque(M5)					4.0	N·m
	Mounting torque(M6)					6.0	N·m
T _{vj}	Junction temperature			-40		150	°C
T _{stg}	Stored temperature			-40		125	°C
W _t	Weight					170	g
Outline	M01						

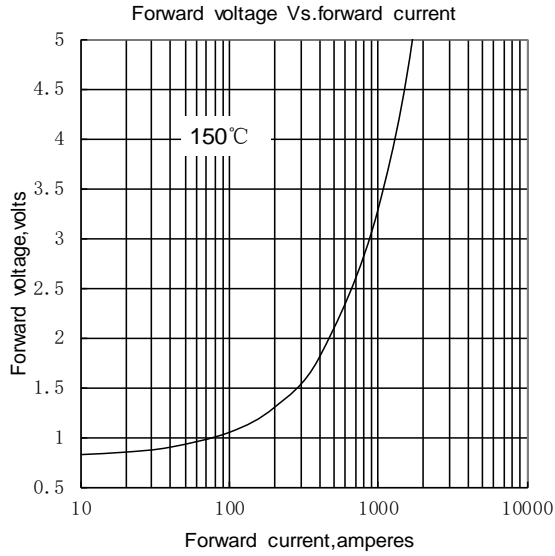

Fig.1

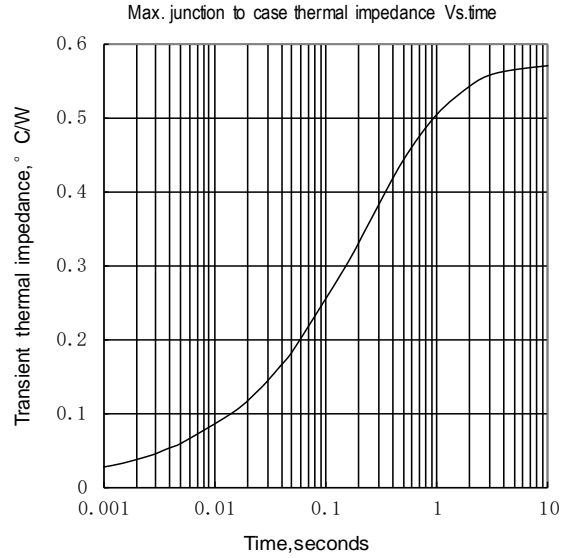

Fig.2

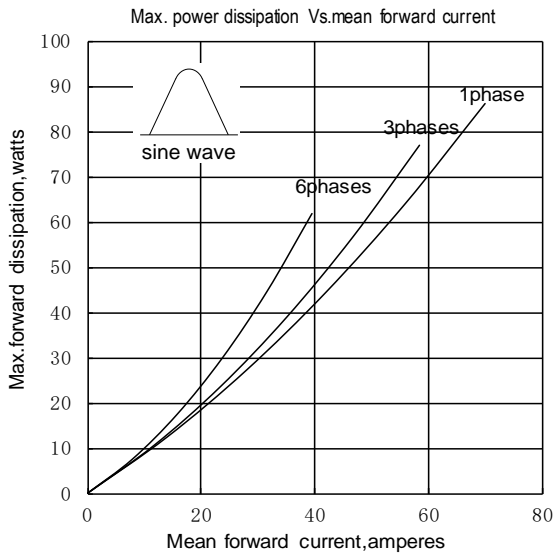

Fig.3

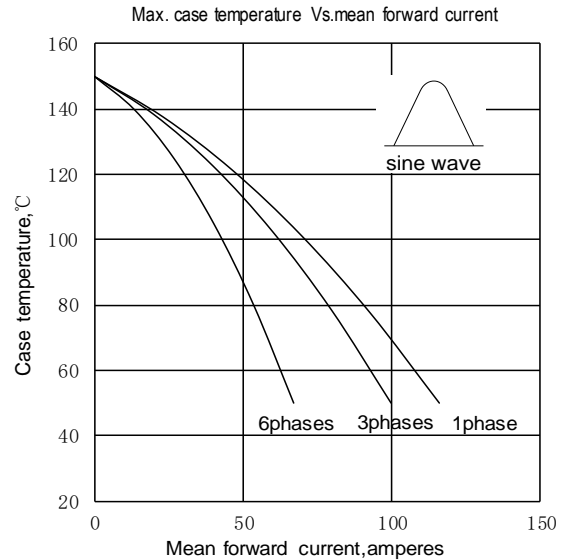

Fig.4

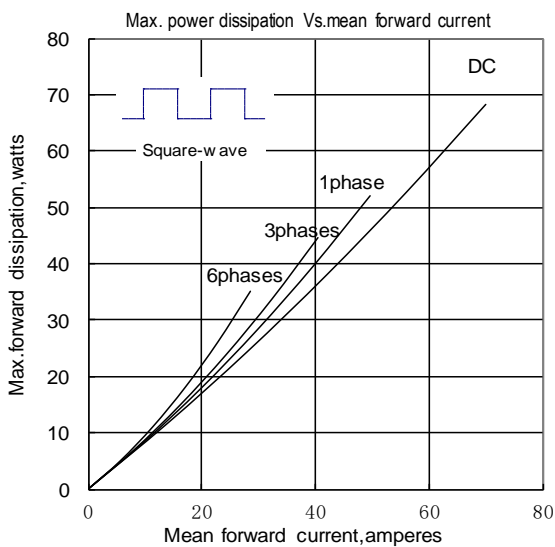

Fig.5

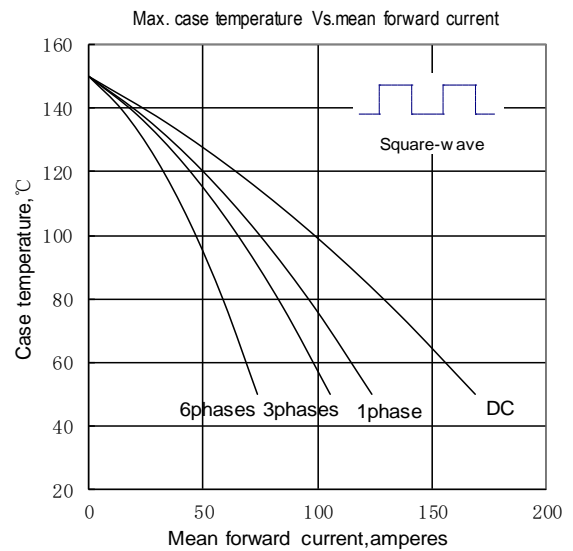

Fig.6

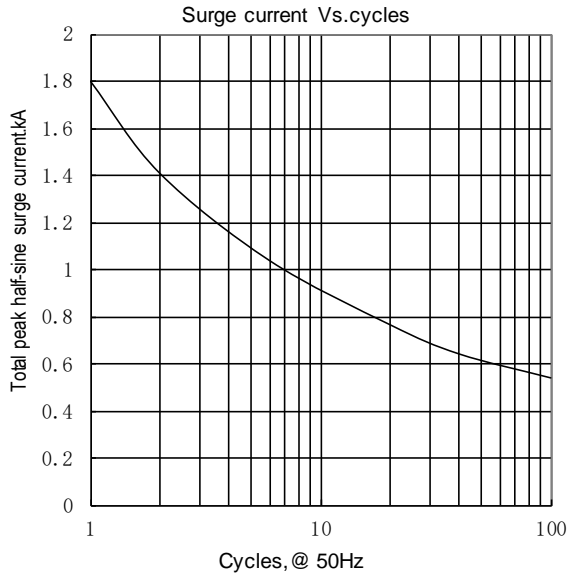

Fig.7

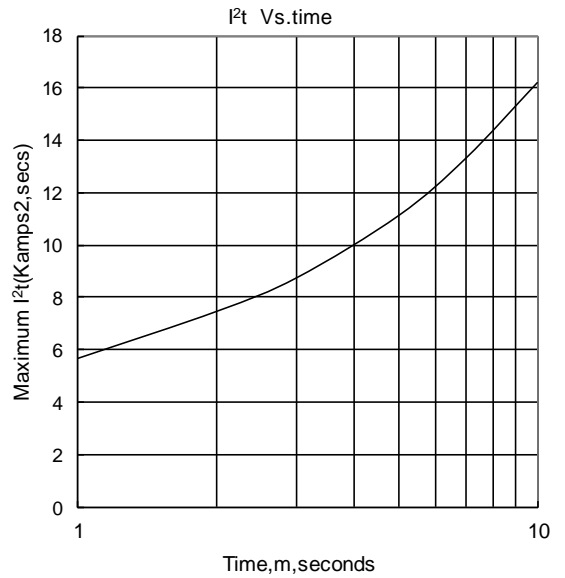
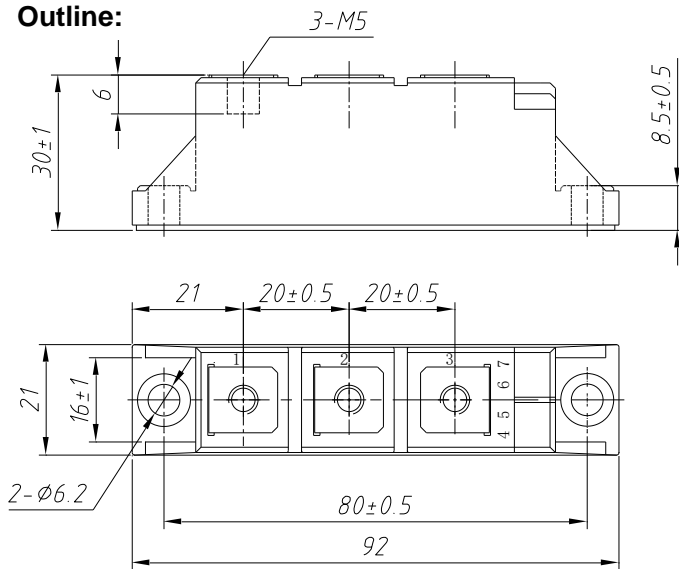
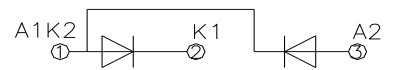

Fig.8

Outline:



MD70D



MR70D

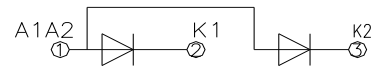

MC70D

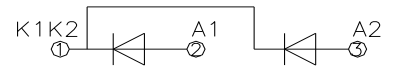

MH70D

