

**Features :**

- Isolated mounting base 4000V~
- Pressure contact technology with Increased power cycling capability
- Space and weight saving

**Typical Applications**

- AC/DC Motor drives
- Various rectifiers
- DC supply for PWM inverter

$V_{DSM}, V_{RSM}$	$V_{DRM}, V_{RRM}$	Type & Outline
2700V	2600V	Mx600T260W
2900V	2800V	Mx600T280W
3100V	3000V	Mx600T300W
3300V	3200V	Mx600T320W
3500V	3400V	Mx600T340W
3700V	3600V	Mx600T360W

SYMBOL	CHARACTERISTIC	TEST CONDITIONS	$T_j(^{\circ}C)$	VALUE			UNIT
				Min	Type	Max	
$I_{T(AV)}$	Mean on-state current	180° half sine wave 50Hz Single side cooled, $T_c=55^{\circ}C$	125			600	A
$I_{T(RMS)}$	RMS on-state current					942	A
$I_{DRM}$ $I_{RRM}$	Repetitive peak current	at $V_{DRM}$ at $V_{RRM}$	125			55	mA
$I_{TSM}$	Surge on-state current	10ms half sine wave $V_R=60\%V_{RRM}$	125			14.0	kA
$I^2t$	$I^2t$ for fusing coordination					980	$A^2s \cdot 10^3$
$V_{TO}$	Threshold voltage		125			1.02	V
$r_T$	On-state slope resistance					0.95	mΩ
$V_{TM}$	Peak on-state voltage	$I_{TM}=1800A$	25			2.95	V
$dv/dt$	Critical rate of rise of off-state voltage	$V_{DM}=67\%V_{DRM}$	125			800	V/μs
$di/dt$	Critical rate of rise of on-state current	Gate source 1.5A $t_r \leq 0.5\mu s$ Repetitive	125			100	A/μs
$I_{GT}$	Gate trigger current	$V_A=12V, I_A=1A$	25	30		200	mA
$V_{GT}$	Gate trigger voltage			0.8		3.0	V
$I_H$	Holding current			10		200	mA
$V_{GD}$	Non-trigger gate voltage	$V_{DM}=67\%V_{DRM}$	125	0.2			V
$R_{th(j-c)}$	Thermal resistance Junction to case	Single side cooled per chip				0.048	$^{\circ}C/W$
$R_{th(c-h)}$	Thermal resistance case to heat sink	Single side cooled per chip				0.024	$^{\circ}C/W$
$V_{iso}$	Isolation voltage	50Hz, R.M.S, $t=1min, I_{iso}: 1mA(MAX)$		4000			V
$F_m$	Terminal connection torque(M12)				14.0		N·m
	Mounting torque(M8)				12.0		N·m
$T_{vj}$	Junction temperature			-40		125	$^{\circ}C$
$T_{stg}$	Stored temperature			-40		125	$^{\circ}C$
$W_t$	Weight				3460		g
Outline	M15						

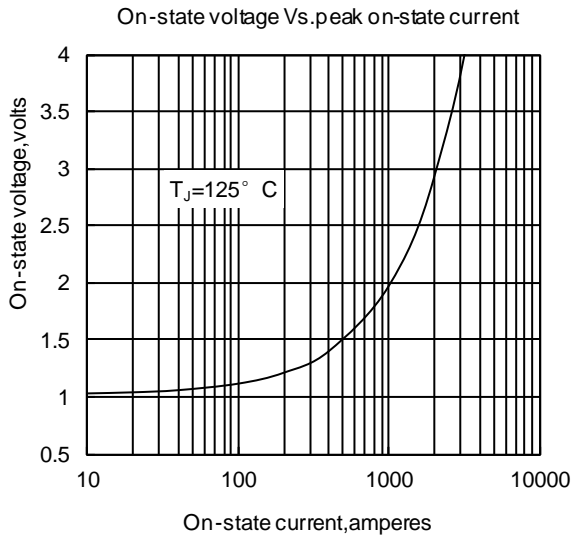

Fig1

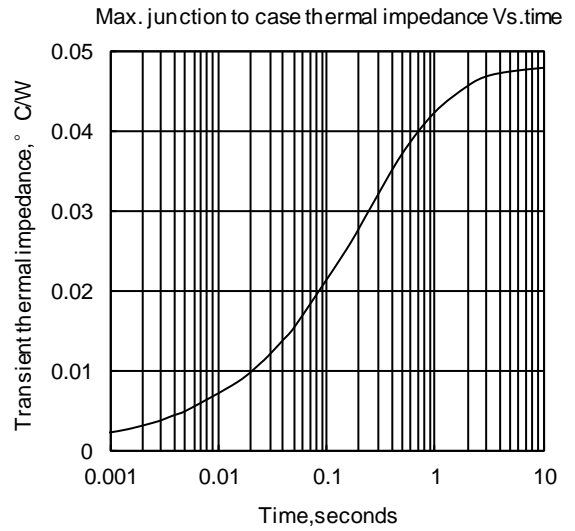

Fig2

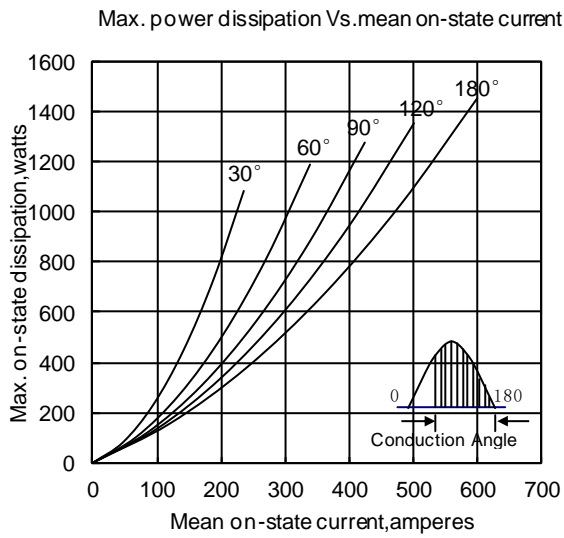

Fig3

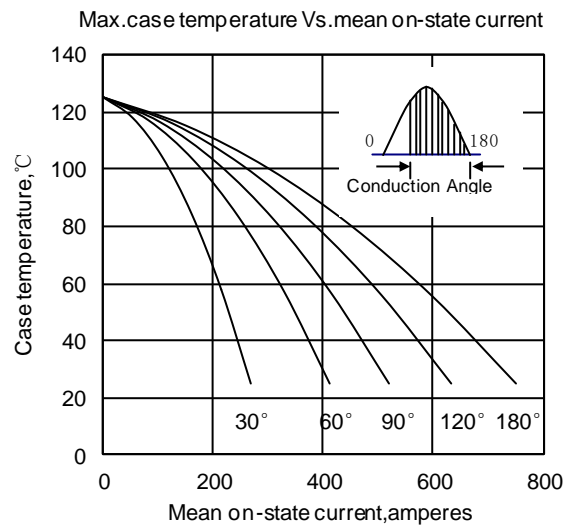

Fig4

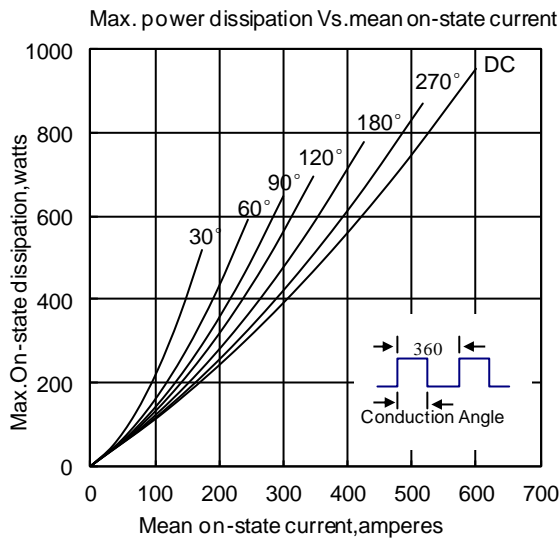

Fig5

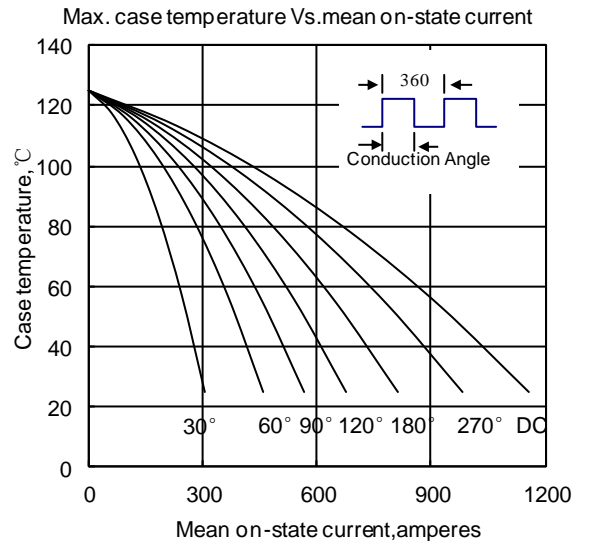

Fig6

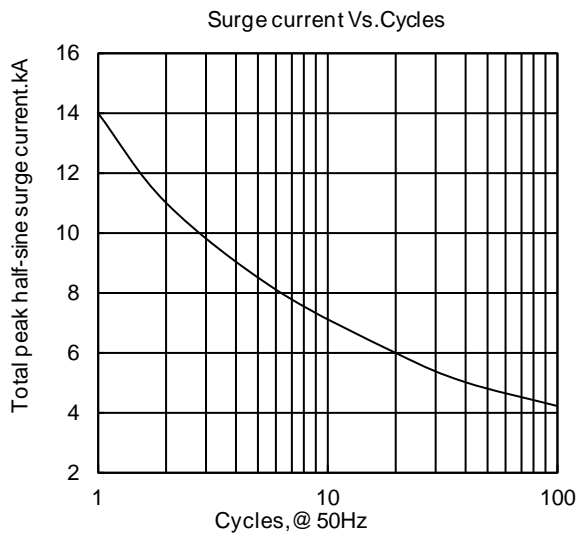

Fig7

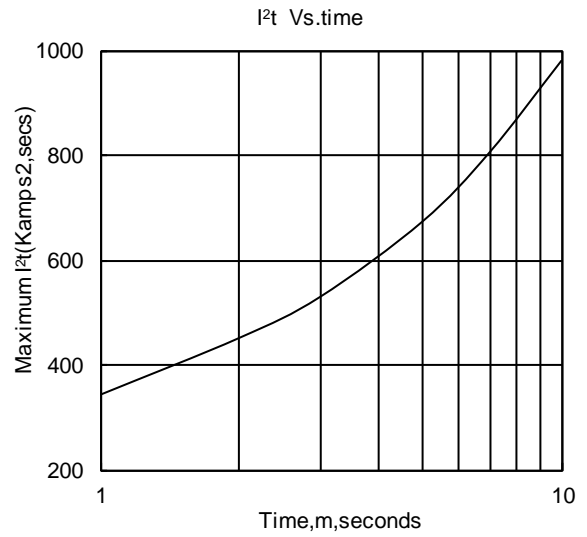

Fig8

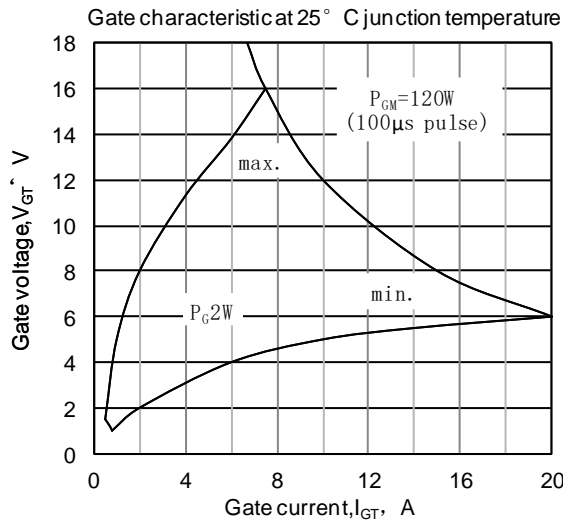

Fig9

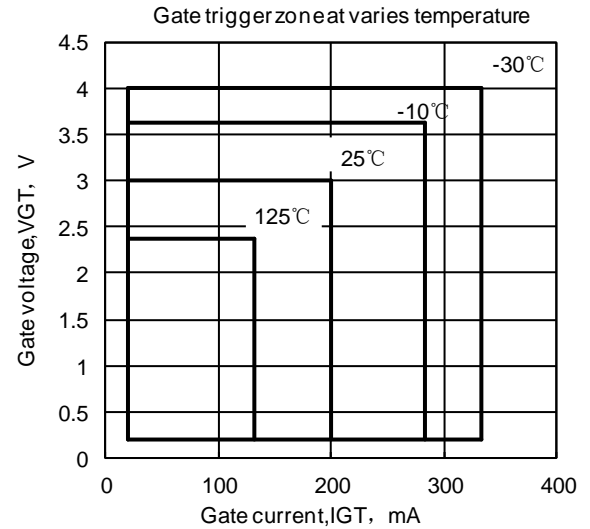
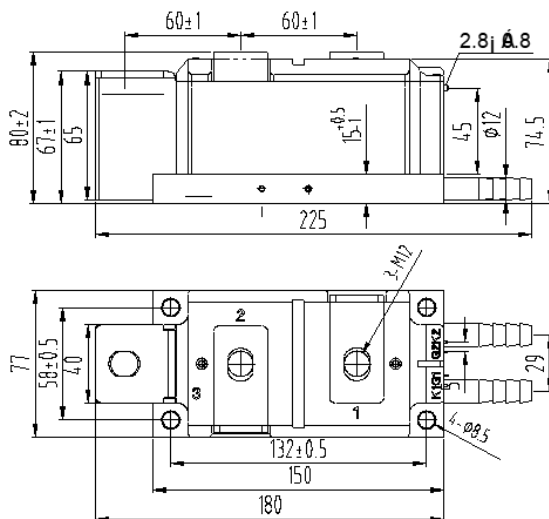
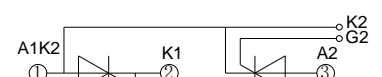

Fig10

Outline:



MD600T\*W



MR600T\*W

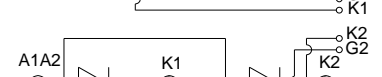

MC600T\*W

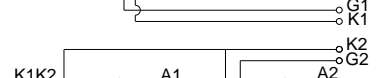

MH600T\*W

