

**Features :**

- Isolated mounting base 3000V~
- Pressure contact technology with Increased power cycling capability
- Space and weight saving

**Typical Applications**

- AC/DC Motor drives
- Various rectifiers
- DC supply for PWM inverter

$V_{DSM}, V_{RSM}$	$V_{DRM}, V_{RRM}$	Type
900V	800V	Mx400T80
1100V	1000V	Mx400T100
1300V	1200V	Mx400T120
1500V	1400V	Mx400T140
1700V	1600V	Mx400T160
1900V	1800V	Mx400T180

SYMBOL	CHARACTERISTIC	TEST CONDITIONS	$T_j$ (°C)	VALUE			UNIT
				Min	Type	Max	
$I_{T(AV)}$	Mean on-state current	180° half sine wave 50Hz Single side cooled, $T_c=85^\circ\text{C}$	125			400	A
$I_{T(RMS)}$	RMS on-state current					628	A
$I_{DRM}$ $I_{RRM}$	Repetitive peak current	at $V_{DRM}$ at $V_{RRM}$	125			35	mA
$I_{TSM}$	Surge on-state current	10ms half sine wave $V_R=60\%V_{RRM}$	125			14.5	kA
$I^2t$	$I^2t$ for fusing coordination					326.25	$\text{A}^2\text{s} \times 10^3$
$V_{TO}$	Threshold voltage		125			0.80	V
$r_T$	On-state slope resistance					0.34	mΩ
$V_{TM}$	Peak on-state voltage	$I_{TM}=1200\text{A}$	25			1.52	V
$dv/dt$	Critical rate of rise of off-state voltage	$V_{DM}=67\%V_{DRM}$	125			1000	V/μs
$di/dt$	Critical rate of rise of on-state current	Gate source 1.5A $t_r \leq 0.5\mu\text{s}$ Repetitive	125			200	A/μs
$I_{GT}$	Gate trigger current	$V_A=12\text{V}, I_A=1\text{A}$	25	30		200	mA
$V_{GT}$	Gate trigger voltage			0.8		3.0	V
$I_H$	Holding current			10		200	mA
$V_{GD}$	Non-trigger gate voltage	$V_{DM}=67\%V_{DRM}$	125	0.2			V
$R_{th(j-c)}$	Thermal resistance Junction to case	Single side cooled per chip				0.065	°C/W
$R_{th(c-h)}$	Thermal resistance case to heatsink	Single side cooled per chip				0.020	°C/W
$V_{iso}$	Isolation voltage	50Hz, R.M.S, $t=1\text{min}, I_{iso}:1\text{mA(MAX)}$		3000			V
$F_m$	Terminal connection torque(M10)				12.0		N·m
	Mounting torque(M6)				6.0		N·m
$T_{vj}$	Junction temperature			-40		125	°C
$T_{stg}$	Stored temperature			-40		125	°C
$W_t$	Weight				1500		g
<b>Outline</b>	M06						

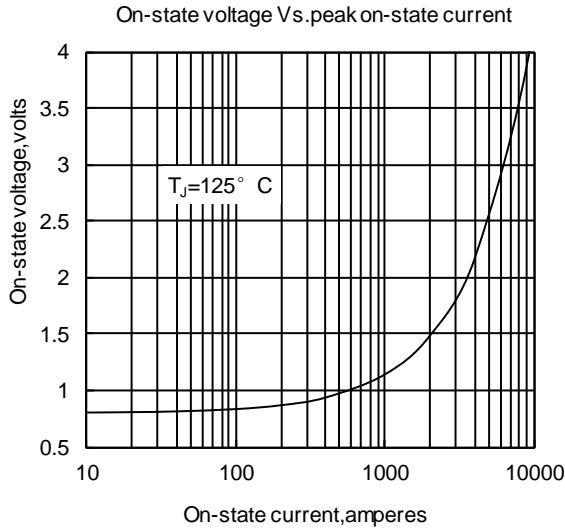

Fig1

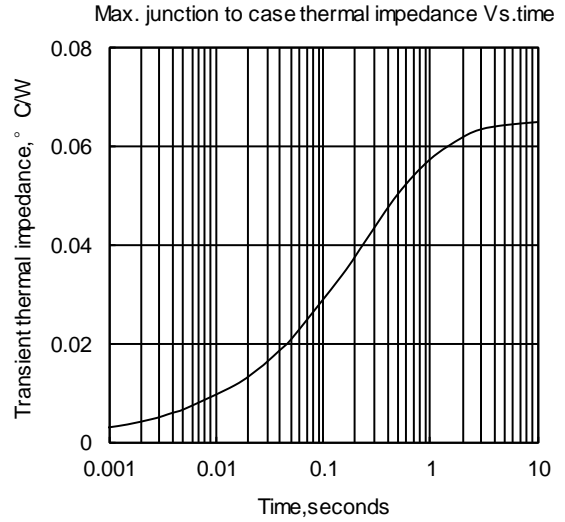

Fig2

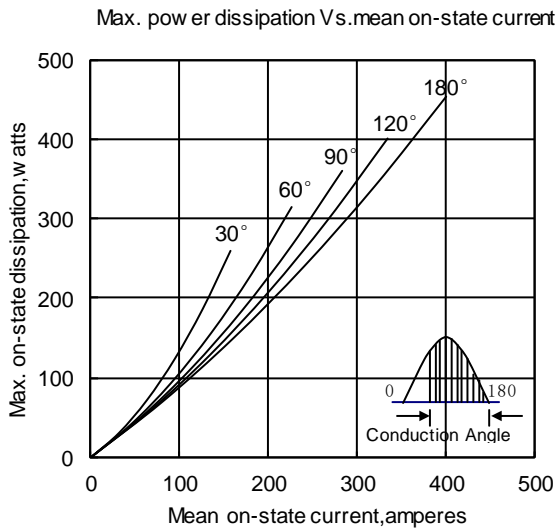

Fig3

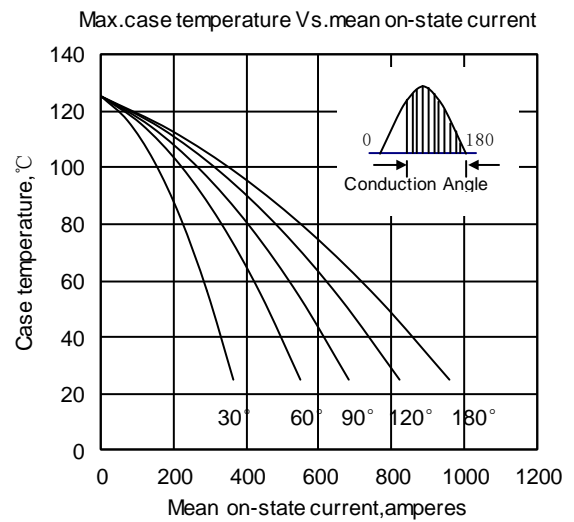

Fig4

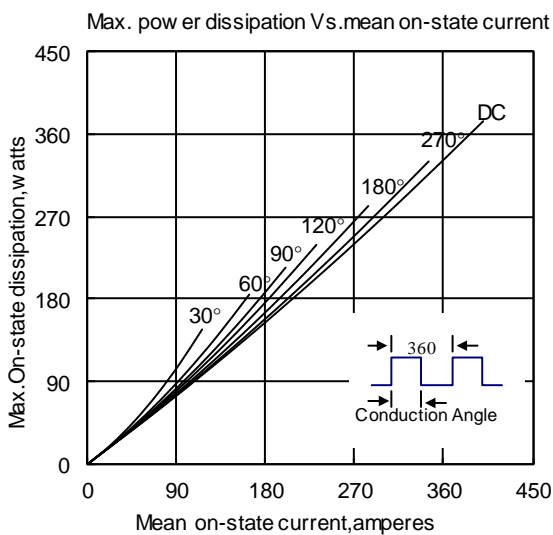

Fig5

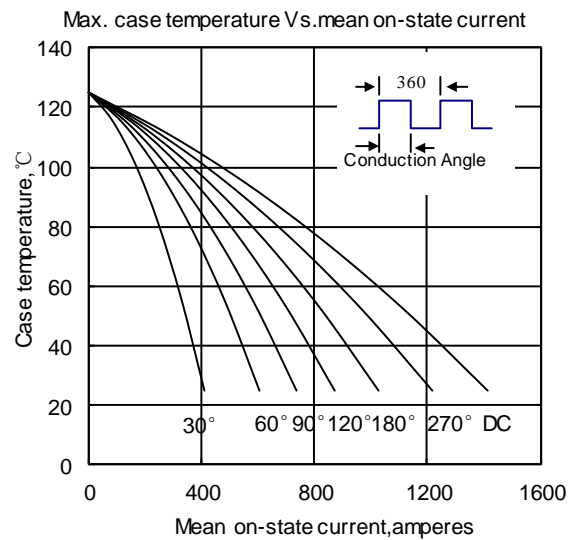

Fig6

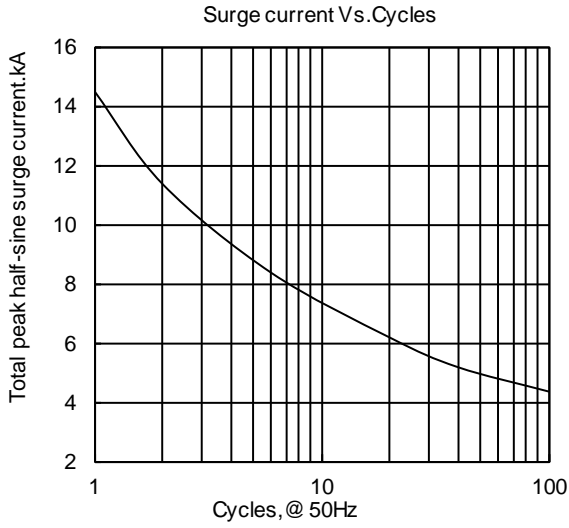

Fig7

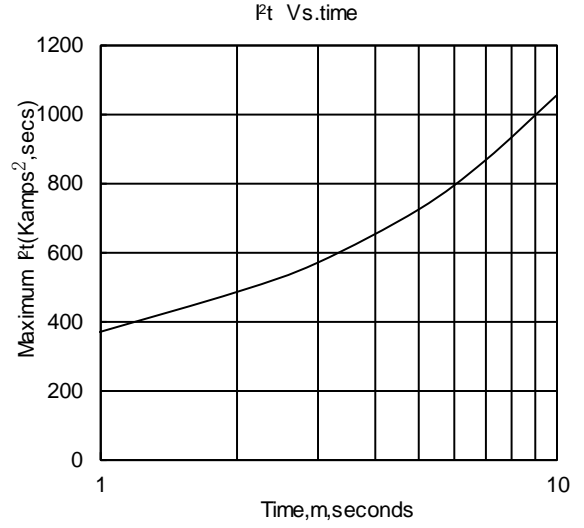

Fig8

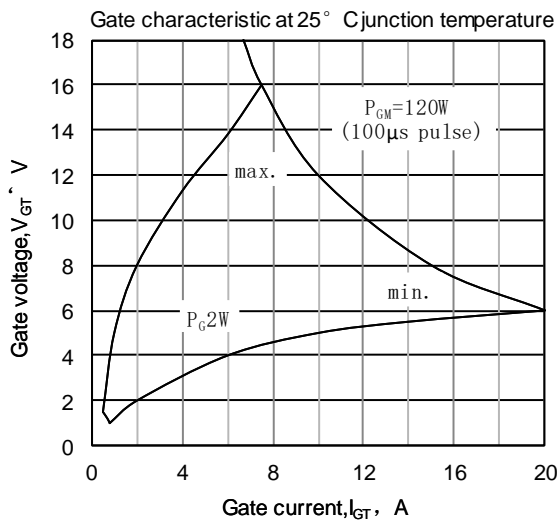

Fig9

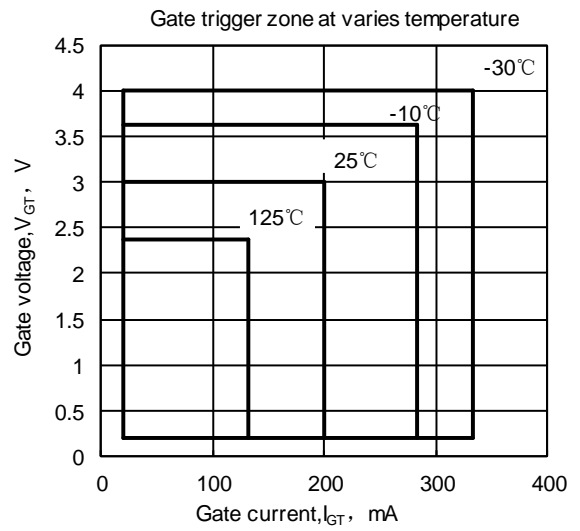
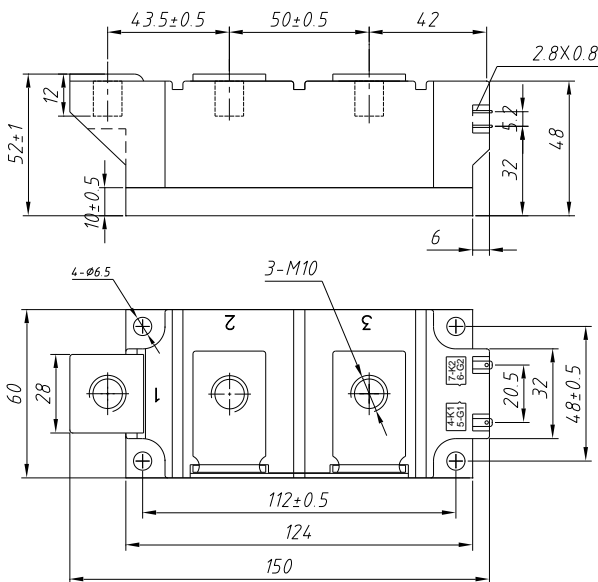
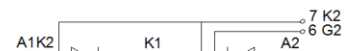

Fig10

Outline:



MD400T



MR400T

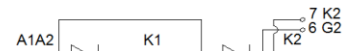

MC400T

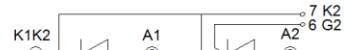

MH400T

