

Features :

- Isolated mounting base 2500V~
- Pressure contact technology with Increased power cycling capability
- Space and weight saving

Typical Applications

- Inverter
- Inductive heating
- Chopper

V_{DSM}, V_{RSM}	V_{DRM}, V_{RRM}	Type
900V	800V	Mx300THF80
1100V	1000V	Mx300THF100
1300V	1200V	Mx300THF120
1500V	1400V	Mx300THF140
1700V	1600V	Mx300THF160

SYMBOL	CHARACTERISTIC	TEST CONDITIONS	$T_j(^{\circ}C)$	VALUE			UNIT
				Min	Type	Max	
$I_{T(AV)}$	Mean on-state current	180° half sine wave 50Hz Single side cooled, $T_c=85^{\circ}C$	125			300	A
$I_{T(RMS)}$	RMS on-state current					471	A
I_{DRM} I_{RRM}	Repetitive peak current	at V_{DRM} at V_{RRM}	125			80	mA
I_{TSM}	Surge on-state current	10ms half sine wave	125			7.30	kA
I^2t	I^2t for fusing coordination	$V_R=60\%V_{RRM}$				266	$A^2s \cdot 10^3$
V_{TO}	Threshold voltage		125			1.28	V
r_T	On-state slope resistance					0.30	$m\Omega$
V_{TM}	Peak on-state voltage	$I_{TM}=900A$	25			2.15	V
dv/dt	Critical rate of rise of off-state voltage	$V_{DM}=67\%V_{DRM}$	125			800	$V/\mu s$
di/dt	Critical rate of rise of on-state current	Gate source 1.5A $t_r \leq 0.5\mu s$ Repetitive	125			200	$A/\mu s$
tq	Circuit commutated turn-off time	$I_{TM}=300A, t_p=2000\mu s, V_R=50V$ $dv/dt=30V/\mu s, di/dt=-20A/\mu s$	125	20		40	μs
t_{rr}	Reverse recovery time	$I_{TM}=300A, t_p=2000\mu s,$ $-di/dt=20A/\mu s, V_R=50V$	125		5		μs
I_{GT}	Gate trigger current	$V_A=12V, I_A=1A$	25	30		200	mA
V_{GT}	Gate trigger voltage			1.0		3.0	V
I_H	Holding current			20		200	mA
V_{GD}	Non-trigger gate voltage	$V_{DM}=67\%V_{DRM}$	125	0.2			V
$R_{th(j-c)}$	Thermal resistance Junction to case	Single side cooled per chip				0.090	$^{\circ}C/W$
$R_{th(c-h)}$	Thermal resistance case to heatsink	Single side cooled per chip				0.040	$^{\circ}C/W$
V_{iso}	Isolation voltage	50Hz, R.M.S, $t=1min, I_{iso}:1mA(MAX)$		2500			V
F_m	Terminal connection torque(M10)				12.0		N·m
	Mounting torque(M6)				6.0		N·m
T_{vj}	Junction temperature			-40		125	$^{\circ}C$
T_{stg}	Stored temperature			-40		125	$^{\circ}C$
W_t	Weight				1275		g
Outline	M05						

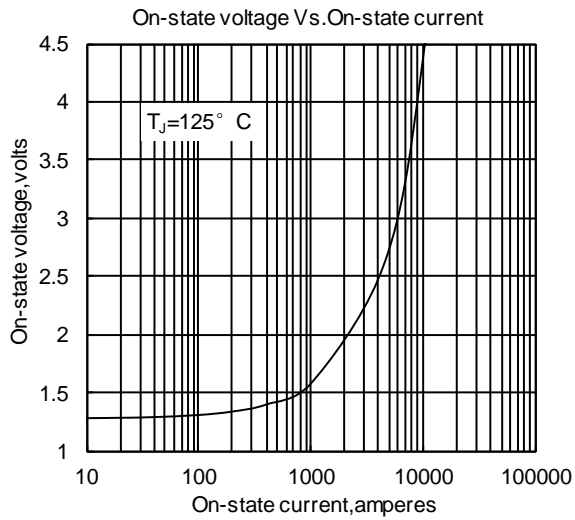

Fig.1

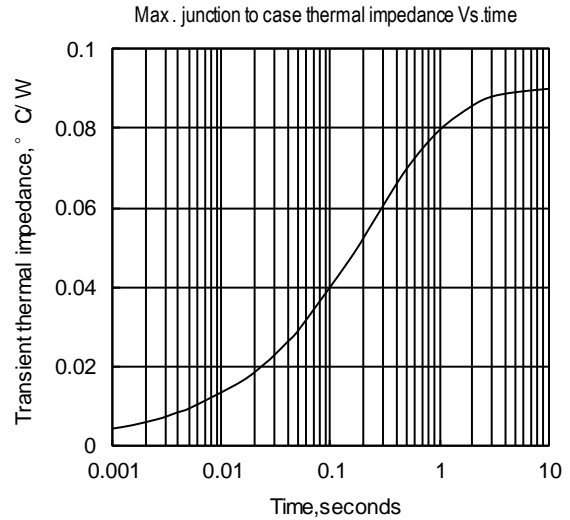

Fig.2

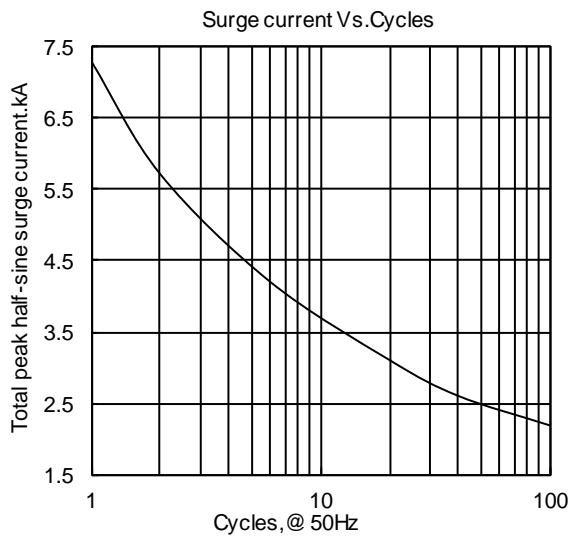

Fig.3

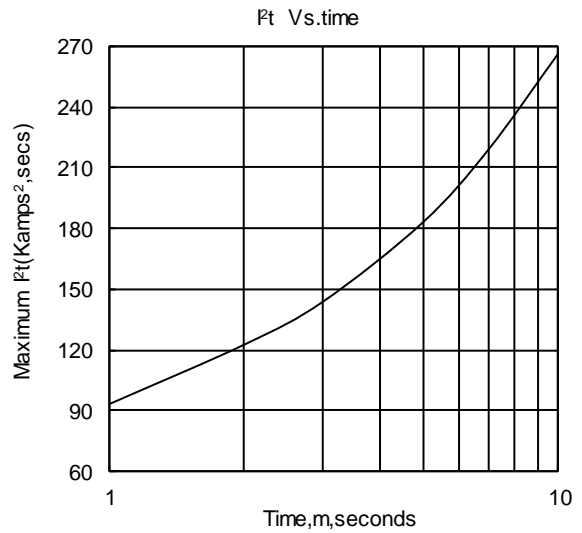

Fig.4

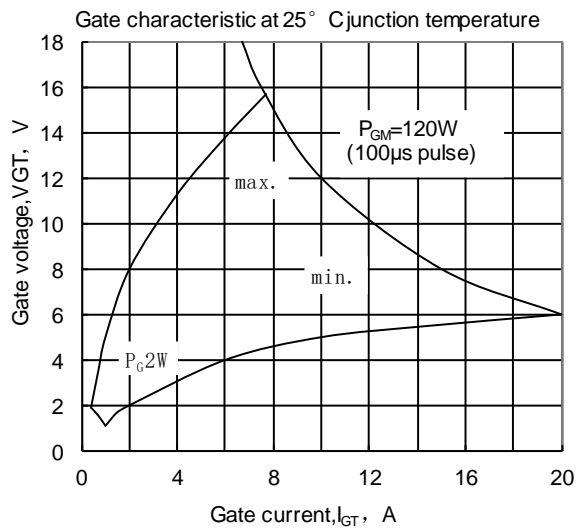

Fig.5

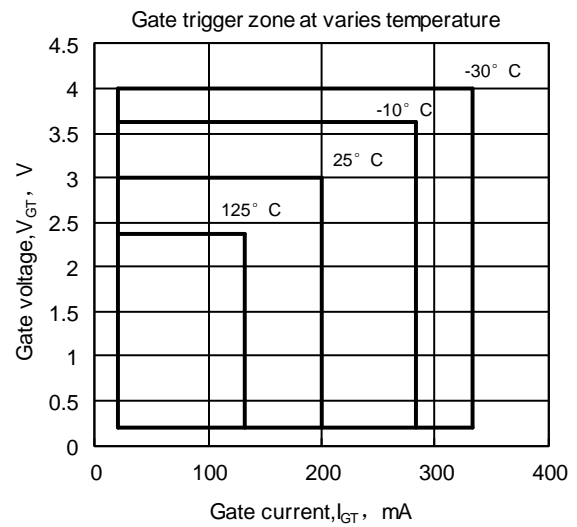
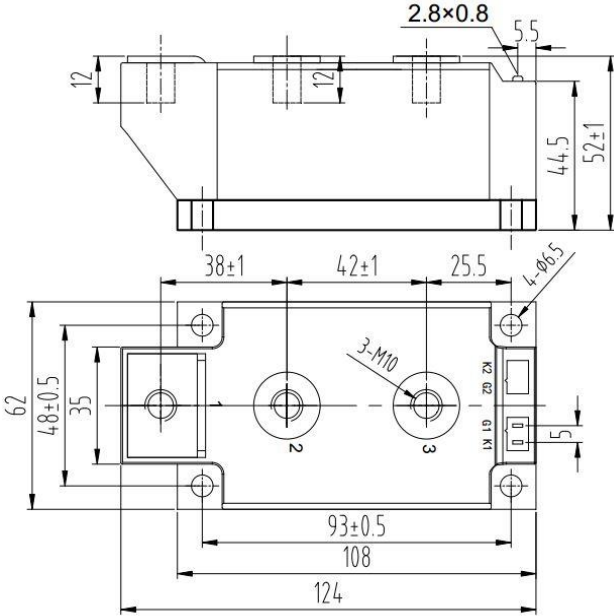
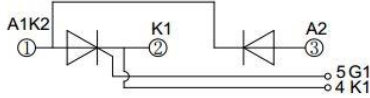

Fig.6

Outline:



MD300THF



MR300THF

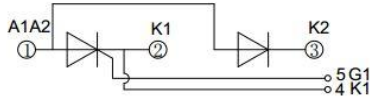

MC300THF

