

Features :

- Isolated mounting base 4000V~
- Pressure contact technology with Increased power cycling capability
- Space and weight saving

Typical Applications

- AC/DC Motor drives
- DC supply for PWM inverter

V_{DSM}, V_{RSM}	V_{DRM}, V_{RRM}	Type
2700V	2600V	Mx300D260
3100V	3000V	Mx300D300
3700V	3600V	Mx300D360

SYMBOL	CHARACTERISTIC	TEST CONDITIONS	$T_j(^{\circ}C)$	VALUE			UNIT
				Min	Type	Max	
$I_{F(AV)}$	Mean forward current	180° half sine wave 50Hz Single side cooled, $T_c=100^{\circ}C$	150			300	A
$I_{F(RMS)}$	RMS forward current		150			471	A
I_{RRM}	Repetitive peak current	at V_{RRM}	150			35	mA
I_{FSM}	Surge forward current	10ms half sine wave $V_R=0.6V_{RRM}$	150			10	kA
I^2t	I^2t for fusing coordination					500	$A^2s \cdot 10^3$
V_{FO}	Threshold voltage		150			0.95	V
r_F	Forward slope resistance					0.70	$m\Omega$
V_{FM}	Peak forward voltage	$I_{FM}=1050A$	25			2.05	V
$R_{th(j-c)}$	Thermal resistance Junction to case	At 180° sine Single side cooled per chip				0.11	$^{\circ}C/W$
$R_{th(c-h)}$	Thermal resistance case to heatsink	At 180° sine Single side cooled per chip				0.04	$^{\circ}C/W$
V_{iso}	Isolation voltage	50Hz, R.M.S, $t=1min, I_{iso}:1mA(max)$		4000			V
F_m	Terminal connection torque(M10)				12.0		N-m
	Mounting torque(M6)				6.0		N-m
T_{vj}	Junction temperature			-40		150	$^{\circ}C$
T_{stg}	Stored temperature			-40		125	$^{\circ}C$
W_t	Weight				1275		g
Outline	M05						

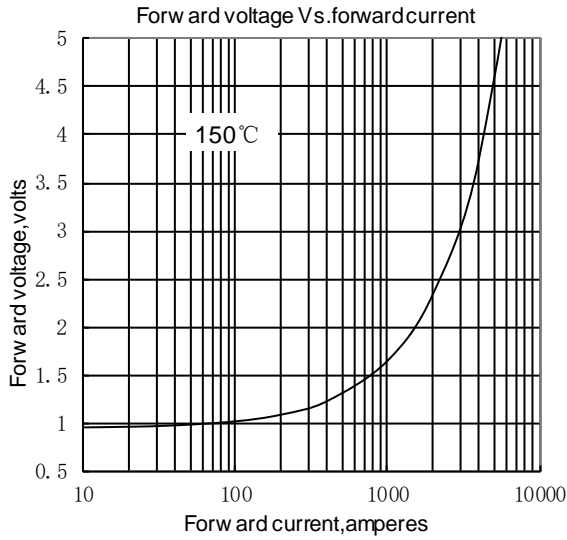

Fig.1

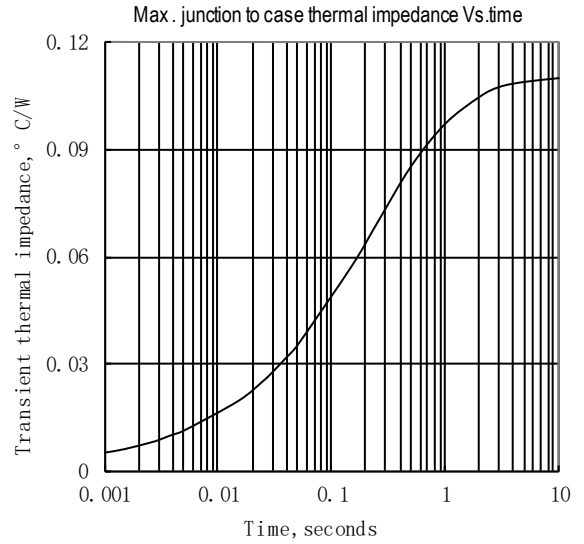

Fig.2

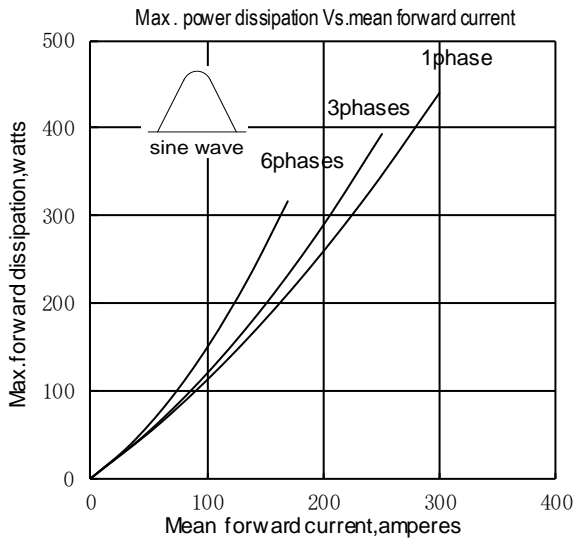

Fig.3

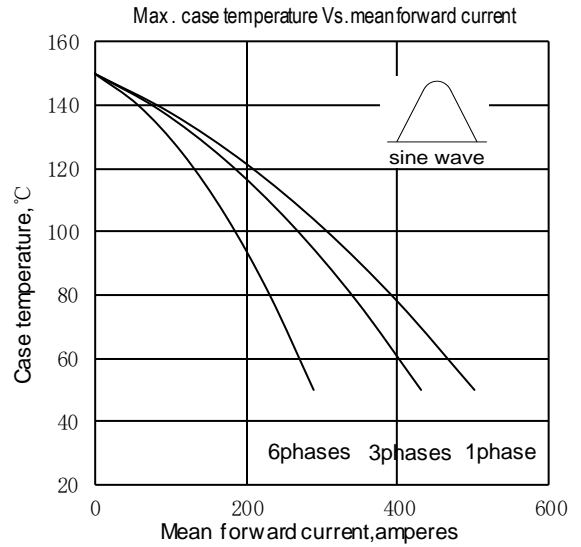

Fig.4

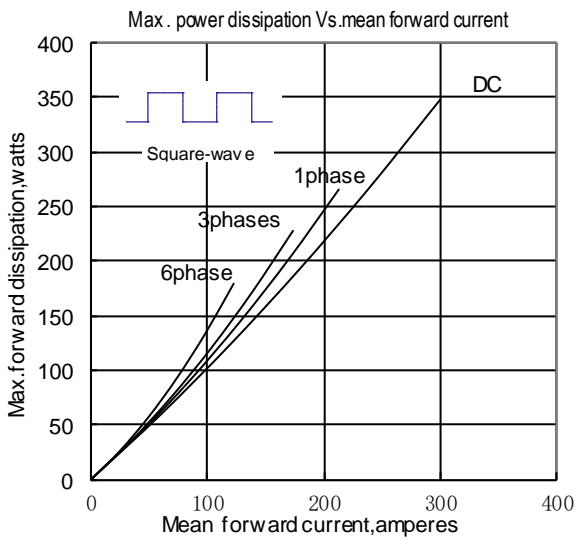

Fig.5

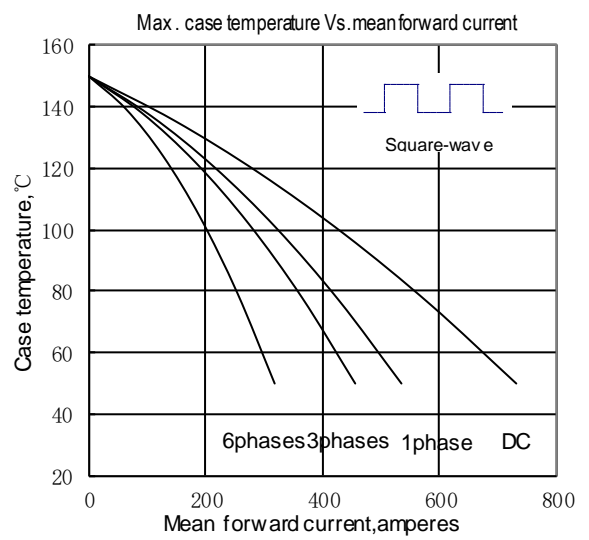

Fig.6

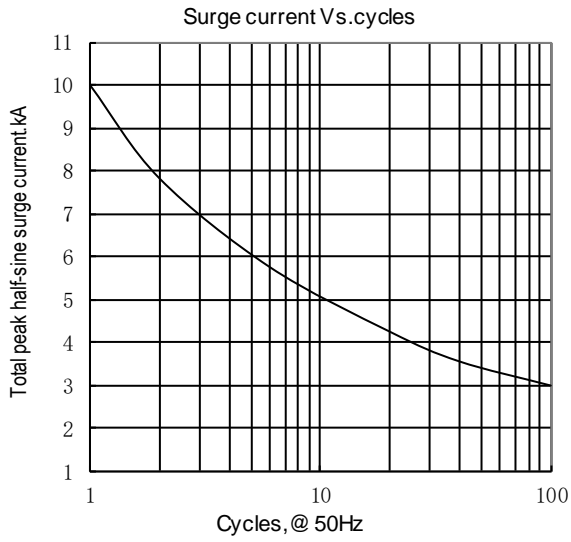

Fig.7

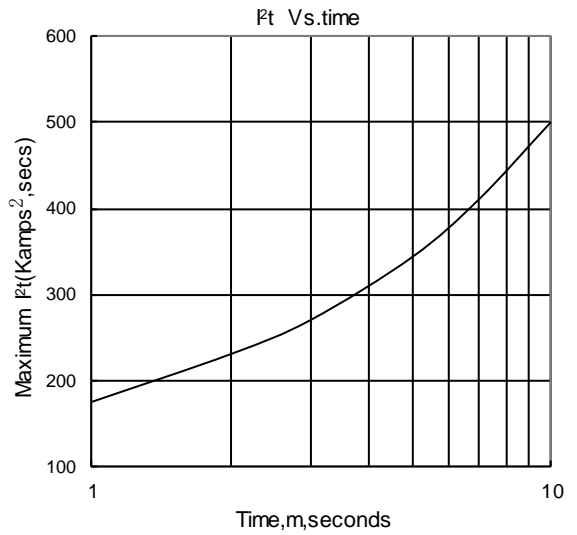
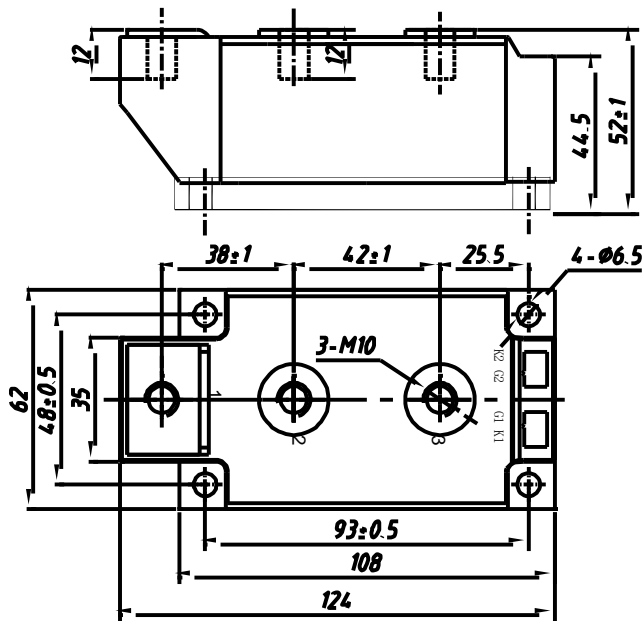
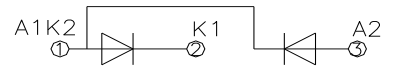

Fig.8

Outline:



MD300D



MR300D

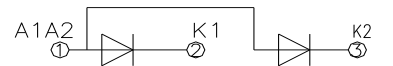

MC300D

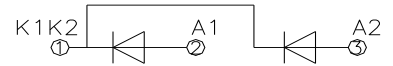

MH300D

