

Features :

- Non-Isolated.Mounting base as anode or cathode terminal
- Pressure contact technology with Increased power cycling capability
- Low on-state voltage drop

Typical Applications

- Welding Power Supply
- Various DC Power supplies
- DC supply for PWM inverter

V_{DSM}, V_{RSM}	V_{DRM}, V_{RRM}	Type
900V	800V	Mx200TH80N*
1100V	1000V	Mx200TH100N*
1300V	1200V	Mx200TH120N*
1500V	1400V	Mx200TH140N*
1700V	1600V	Mx200TH160N*
1900V	1800V	Mx200TH180N*

SYMBOL	CHARACTERISTIC	TEST CONDITIONS	$T_j(^{\circ}C)$	VALUE			UNIT
				Min	Type	Max	
$I_{T(AV)}$	Mean on-state current	180° half sine wave 50Hz Single side cooled, $T_c=90^{\circ}C$	125			200	A
$I_{T(RMS)}$	RMS on-state current					314	A
I_{DRM} I_{RRM}	Repetitive peak current	at V_{DRM} at V_{RRM}	125			12	mA
I_{TSM}	Surge on-state current	10ms half sine wave	125			5.2	kA
I^2t	I^2t for fusing coordination	$V_R=60\%V_{RRM}$				135	$A^2s \times 10^3$
V_{TO}	Threshold voltage		125			0.80	V
r_T	On-state slope resistance					1.15	m Ω
V_{TM}	Peak on-state voltage	$I_{TM}=600A$	25			1.62	V
dv/dt	Critical rate of rise of off-state voltage	$V_{DM}=67\%V_{DRM}$	125			800	V/ μs
di/dt	Critical rate of rise of on-state current	Gate source 1.5A $t_r \leq 0.5\mu s$ Repetitive	125			100	A/ μs
I_{GT}	Gate trigger current	$V_A=12V, I_A=1A$	25	30		150	mA
V_{GT}	Gate trigger voltage			0.7		2.5	V
I_H	Holding current			10		120	mA
V_{GD}	Non-trigger gate voltage	At $67\%V_{DRM}$	125	0.2			V
$R_{th(j-c)}$	Thermal resistance Junction to case	Single side cooled per chip				0.130	$^{\circ}C/W$
$R_{th(c-h)}$	Thermal resistance case to heatsink	Single side cooled per chip				0.100	$^{\circ}C/W$
F_m	Terminal connection torque(M6)				6.0		N-m
	Mounting torque(M6)				6.0		N-m
T_{vj}	Junction temperature			-40		125	$^{\circ}C$
T_{sig}	Stored temperature			-40		125	$^{\circ}C$
W_t	Weight				280		g
Outline	M10						

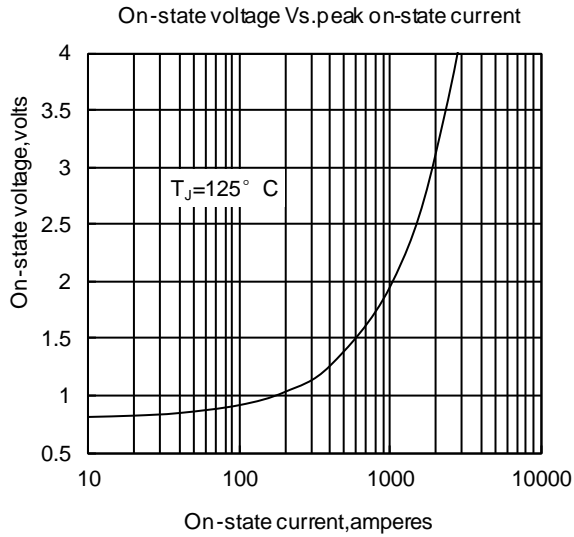

Fig1

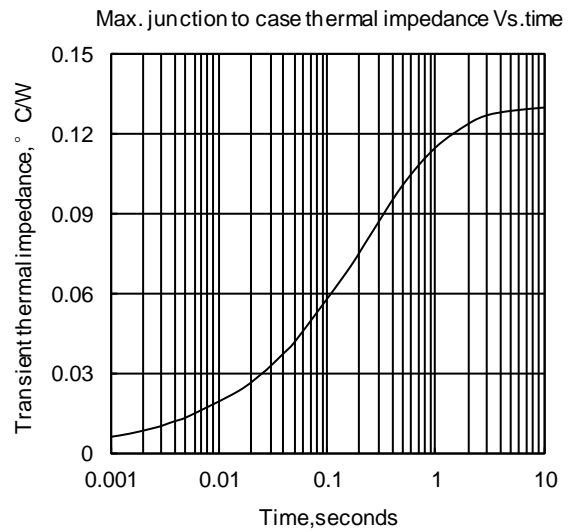

Fig2

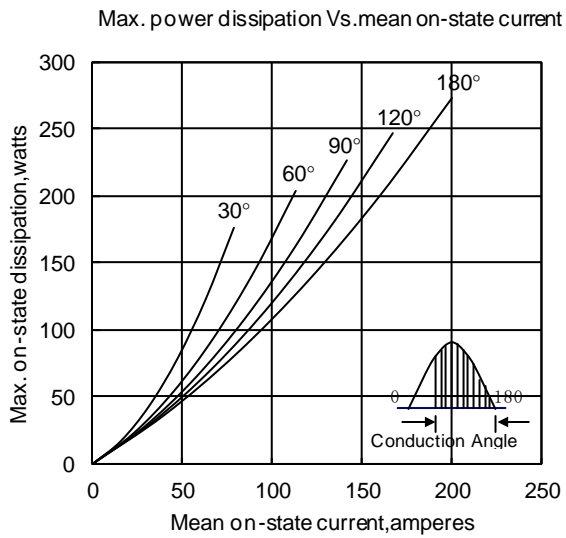

Fig3

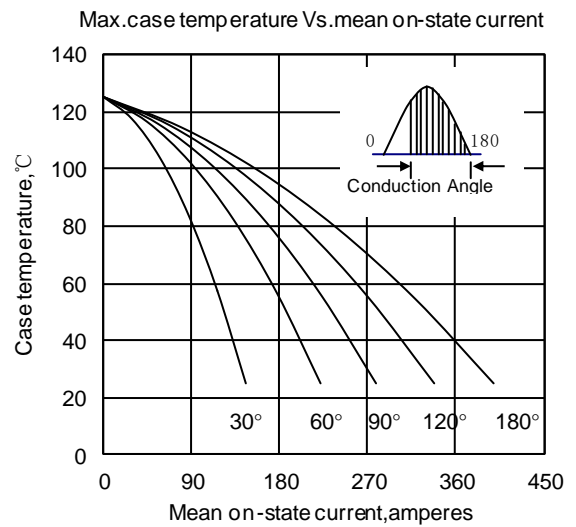

Fig4

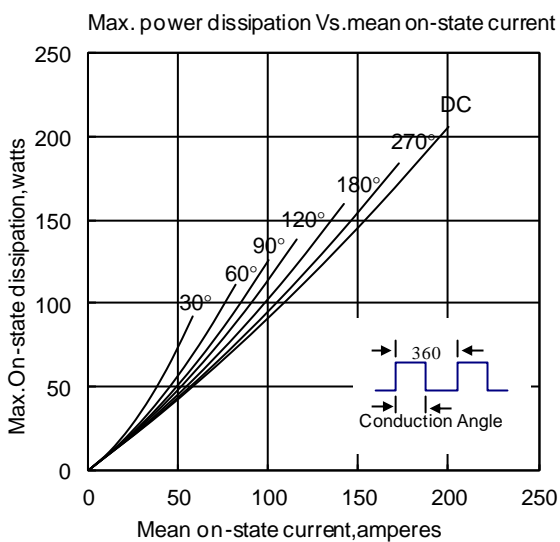

Fig5

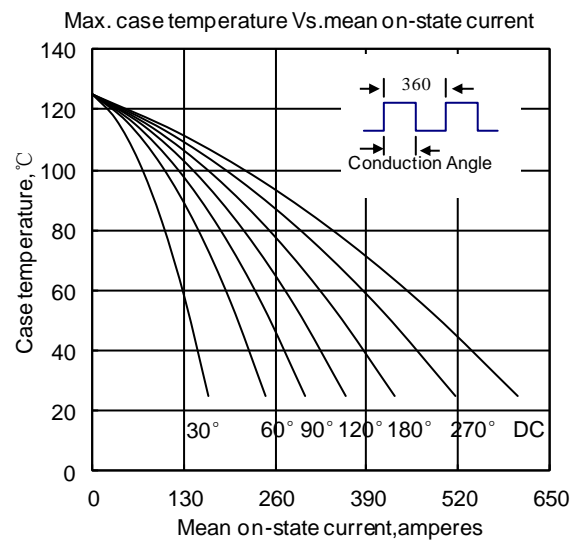

Fig6

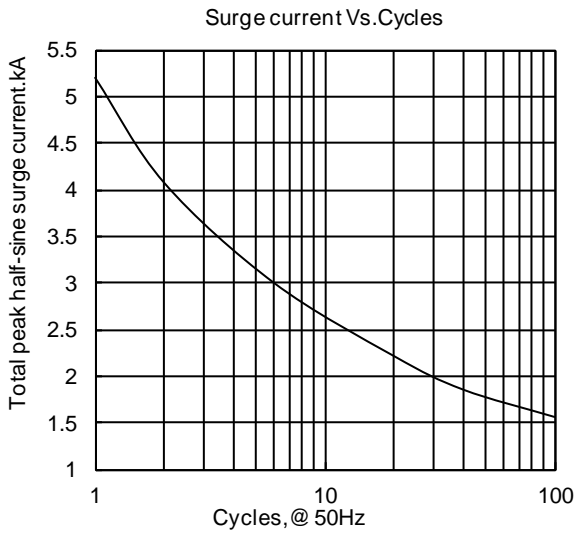

Fig7

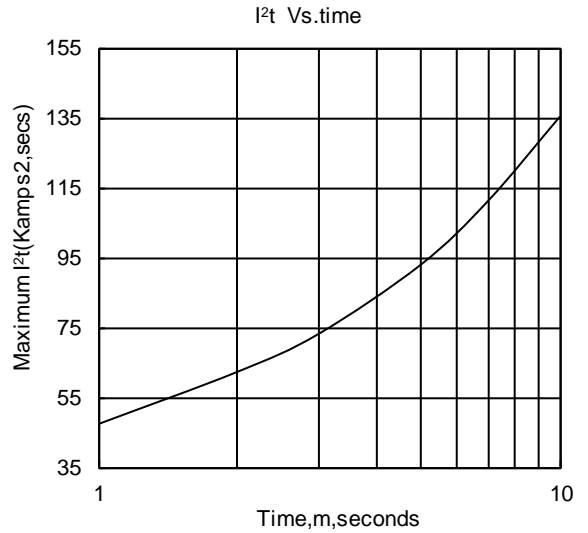

Fig8

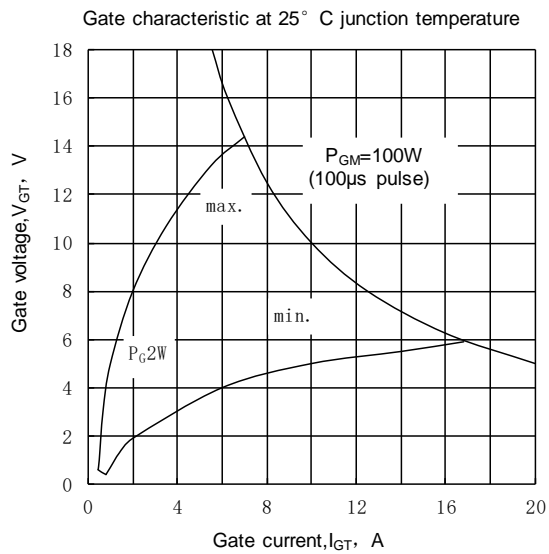

Fig.9

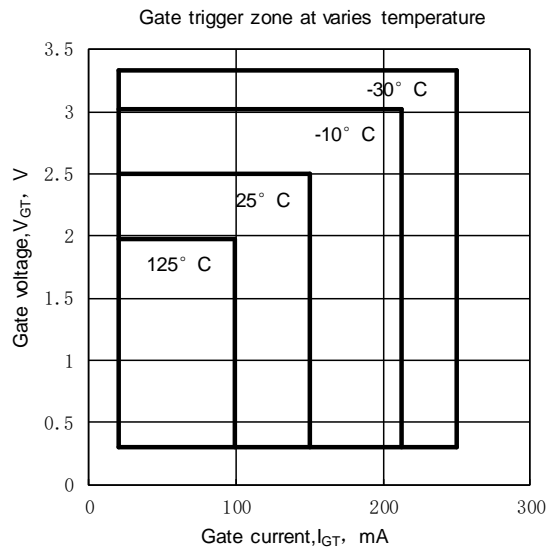
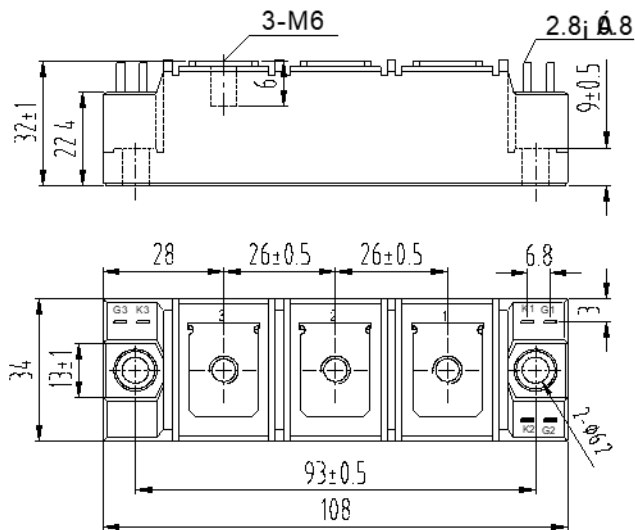
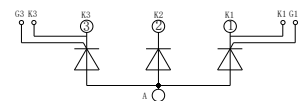

Fig.10

Outline:



ME200TH*NK



MF200TH*NA

