

Features :

- Isolated mounting base 3000V~
- Solder joint technology with increased power cycling capability
- Space and weight saving

Typical Applications

- Various rectifiers
- DC supply for PWM inverter

V_{RSM}	V_{RRM}	Type
900V	800V	Mx182D80S
1100V	1000V	Mx182D100S
1300V	1200V	Mx182D120S
1500V	1400V	Mx182D140S
1700V	1600V	Mx182D160S
1900V	1800V	Mx182D180S

SYMBOL	CHARACTERISTIC	TEST CONDITIONS	$T_j(^{\circ}C)$	VALUE			UNIT
				Min	Type	Max	
$I_{F(AV)}$	Mean forward current	180° half sine wave 50Hz Single side cooled, $T_c=100^{\circ}C$	150			182	A
$I_{F(RMS)}$	RMS forward current		150			286	A
I_{RRM}	Repetitive peak current	at V_{RRM}	150			12	mA
I_{FSM}	Surge forward current	10ms half sine wave $V_R=0.6V_{RRM}$	150			4	kA
I^2t	I^2t for fusing coordination					80	$A^2s \cdot 10^3$
V_{FO}	Threshold voltage		150			0.83	V
r_F	Forward slope resistance					1.2	m Ω
V_{FM}	Peak forward voltage	$I_{FM}=550A$	25			1.55	V
$R_{th(j-c)}$	Thermal resistance Junction to case	Single side cooled per chip				0.19	$^{\circ}C/W$
$R_{th(c-h)}$	Thermal resistance case to heatsink	Single side cooled per chip				0.08	$^{\circ}C/W$
V_{iso}	Isolation voltage	50Hz, R.M.S, $t=1min$, $I_{iso}:1mA(max)$		3000			V
F_m	Terminal connection torque(M6)				6		N-m
	Mounting torque(M6)				6		N-m
T_{stg}	Stored temperature			-40		125	$^{\circ}C$
W_t	Weight				150		g
Outline	M17						

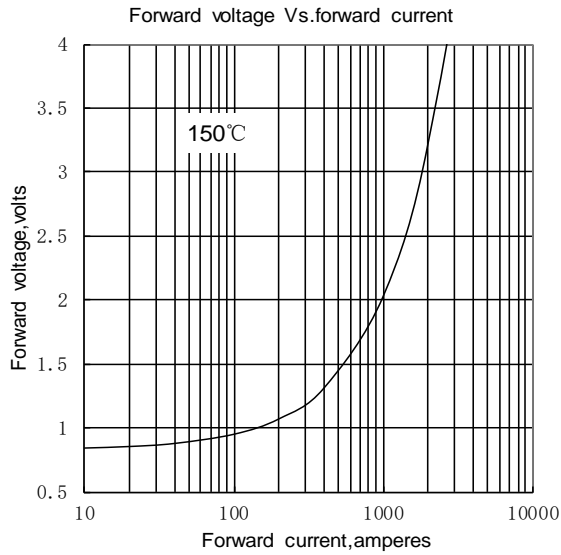

Fig1

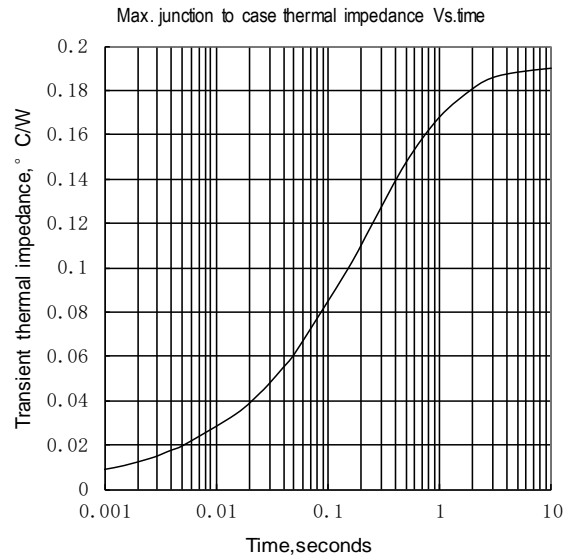

Fig2

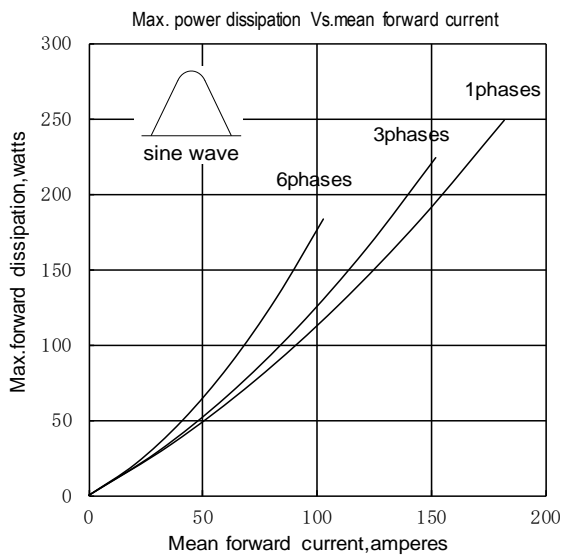

Fig3

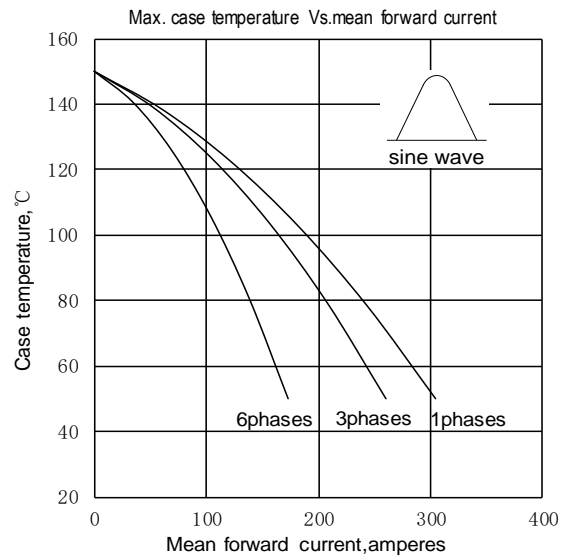

Fig4

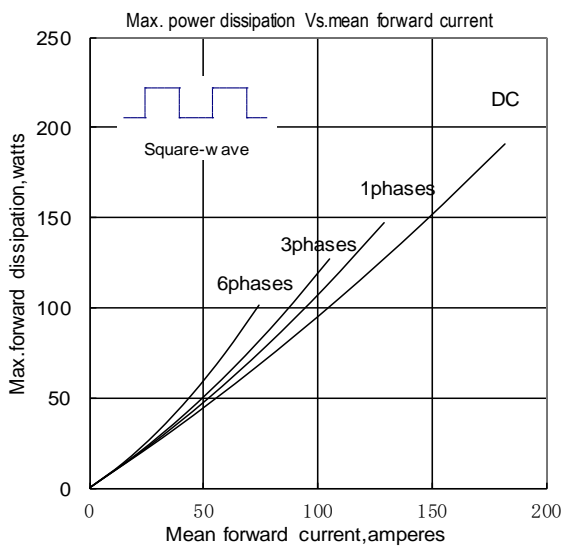

Fig5

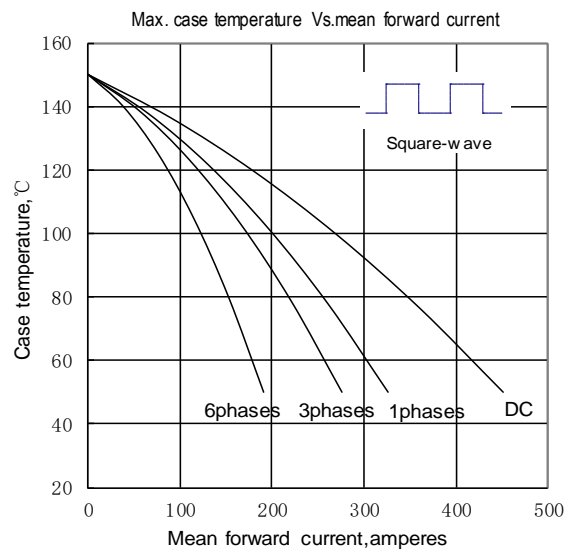

Fig6

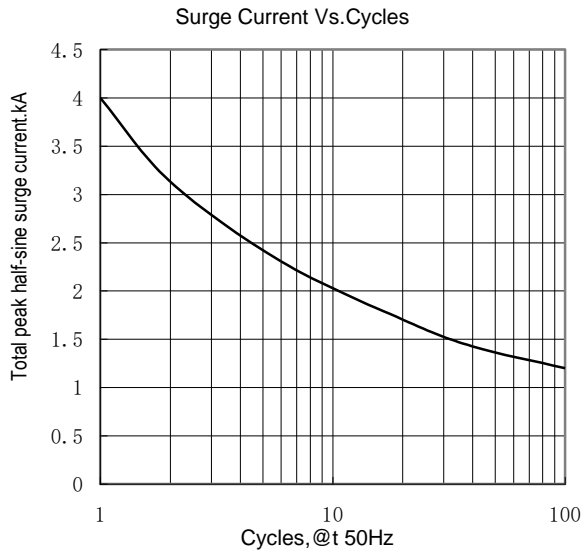

Fig7

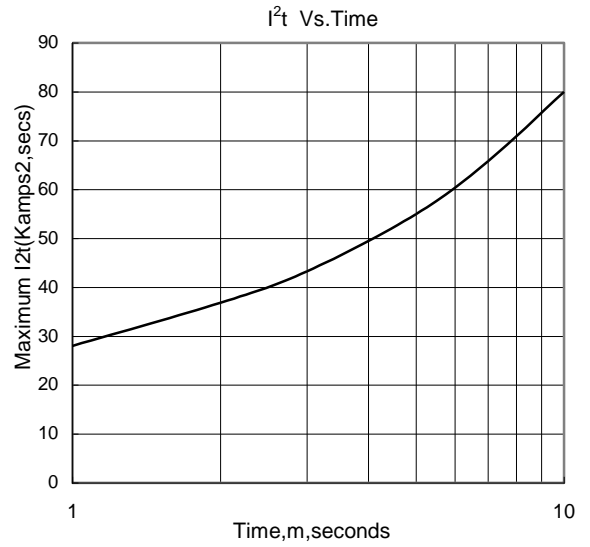
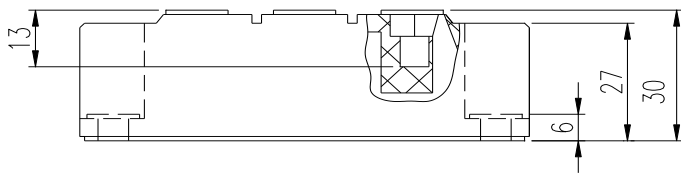
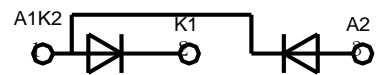
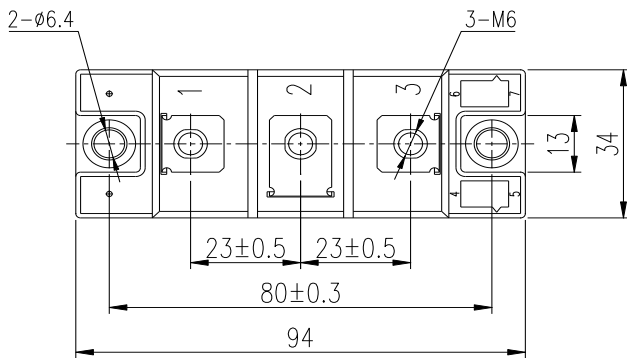

Fig8

Outline:



MD182D*S



MH182D*S

