

Features :

- Isolated mounting base 3000V~
- Pressure contact technology with Increased power cycling capability
- Space and weight saving

Typical Applications

- AC/DC Motor drives
- Various rectifiers
- DC supply for PWM inverter

V_{DSM}, V_{RSM}	V_{DRM}, V_{RRM}	Type
2100V	2000V	Mx160TH200
2300V	2200V	Mx160TH220
2600V	2500V	Mx160TH250

SYMBOL	CHARACTERISTIC	TEST CONDITIONS	$T_j(^{\circ}C)$	VALUE			UNIT
				Min	Type	Max	
$I_{T(AV)}$	Mean on-state current	180° half sine wave 50Hz Single side cooled, $T_c=85^{\circ}C$	125			160	A
$I_{T(RMS)}$	RMS on-state current					251	A
I_{DRM} I_{RRM}	Repetitive peak current	at V_{DRM} at V_{RRM}	125			30	mA
I_{TSM}	Surge on-state current	10ms half sine wave	125			4.2	kA
I^2t	I^2t for fusing coordination	$V_R=60\%V_{RRM}$				88.2	$A^2s \cdot 10^3$
V_{TO}	Threshold voltage		125			0.85	V
r_T	On-state slope resistance					1.53	mΩ
V_{TM}	Peak on-state voltage	$I_{TM}=480A$	25			1.90	V
dv/dt	Critical rate of rise of off-state voltage	$V_{DM}=67\%V_{DRM}$	125			1000	V/μs
di/dt	Critical rate of rise of on-state current	Gate source 1.5A $t_r \leq 0.5\mu s$ Repetitive	125			200	A/μs
I_{GT}	Gate trigger current	$V_A=12V, I_A=1A$	25	30		150	mA
V_{GT}	Gate trigger voltage			0.8		2.5	V
I_H	Holding current			20		150	mA
V_{GD}	Non-trigger gate voltage	$V_{DM}=67\%V_{DRM}$	125	0.2			V
$R_{th(j-c)}$	Thermal resistance Junction to case	Single side cooled per chip				0.17	$^{\circ}C/W$
$R_{th(c-h)}$	Thermal resistance case to heat sink	Single side cooled per chip				0.08	$^{\circ}C/W$
V_{iso}	Isolation voltage	50Hz, R.M.S, $t=1min, I_{iso}: 1mA(MAX)$		3000			V
F_m	Terminal connection torque (M6)				6.0		N·m
	Mounting torque (M6)				6.0		N·m
T_{vj}	Junction temperature			-40		125	$^{\circ}C$
T_{stg}	Stored temperature			-40		125	$^{\circ}C$
W_t	Weight				320		g
Outline	M02						

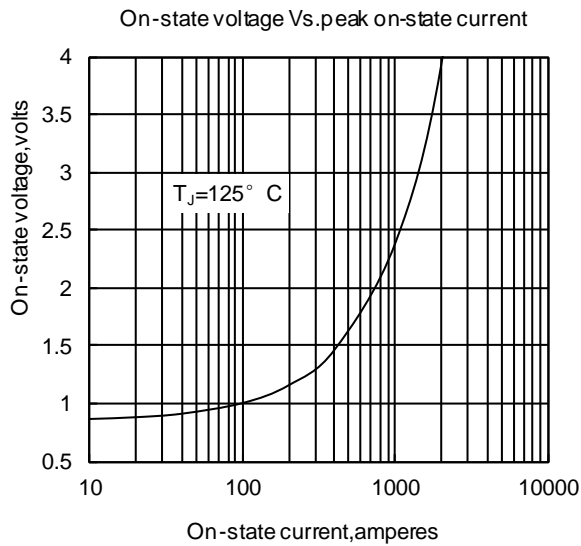

Fig. 1

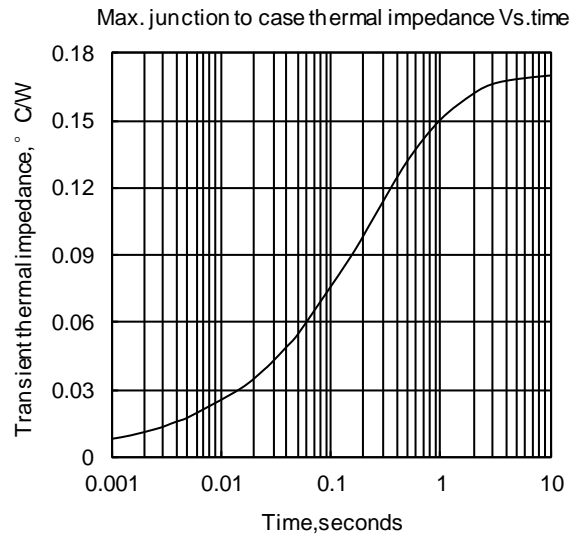

Fig. 2

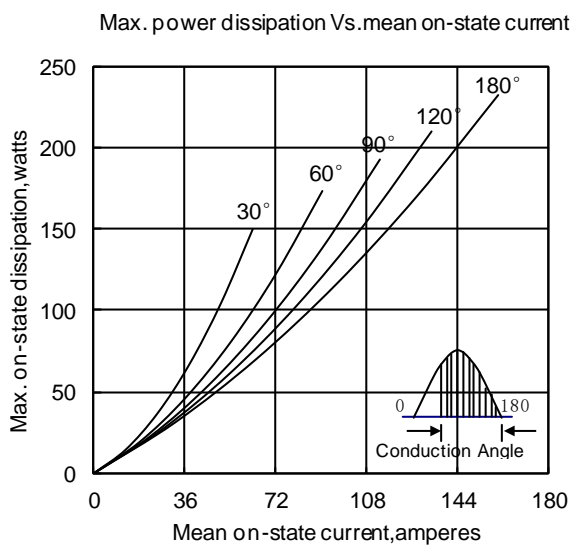

Fig. 3

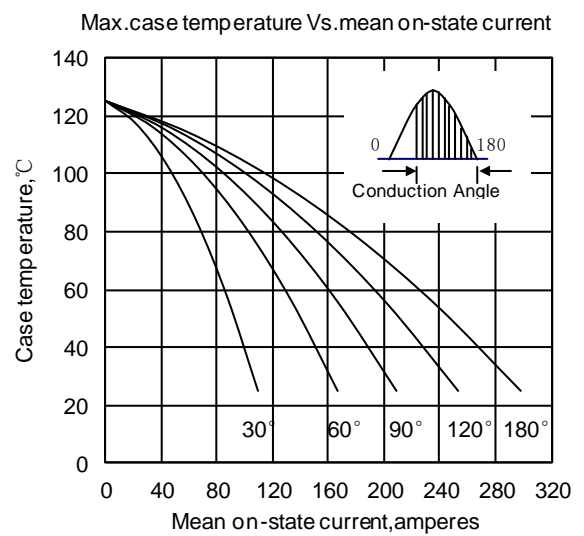

Fig. 4

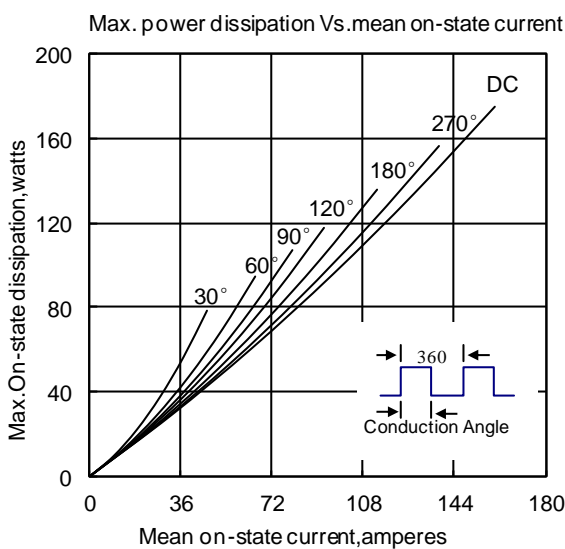

Fig. 5

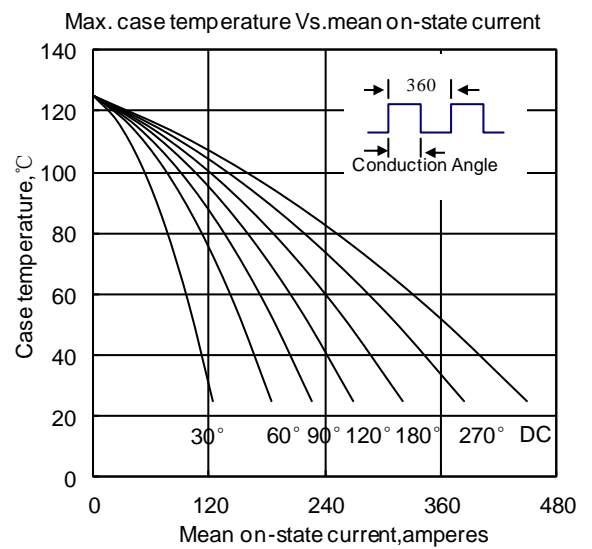

Fig. 6

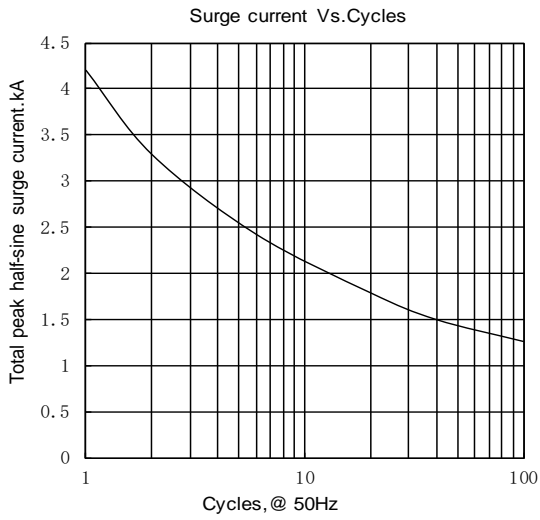

Fig.7

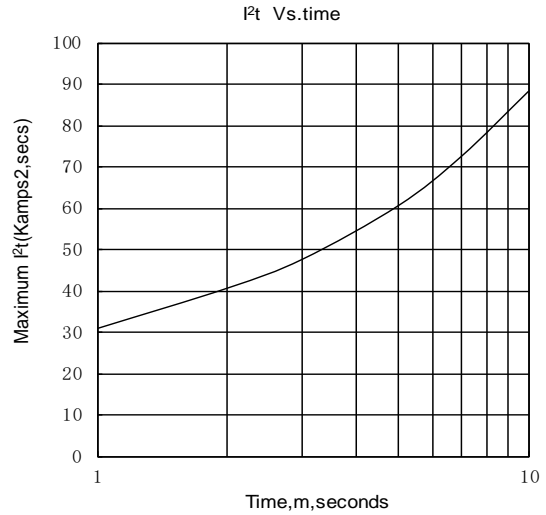

Fig.8

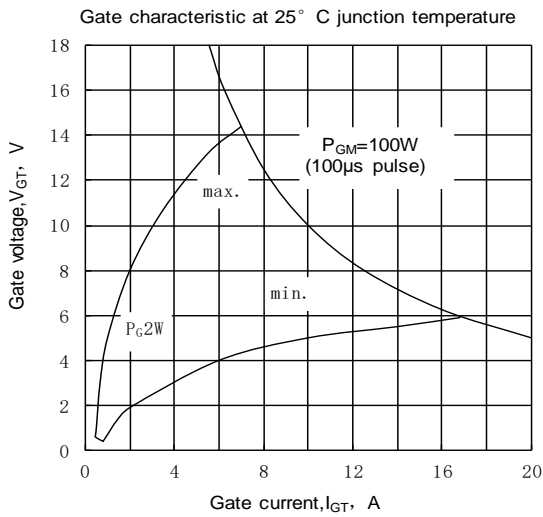

Fig.9

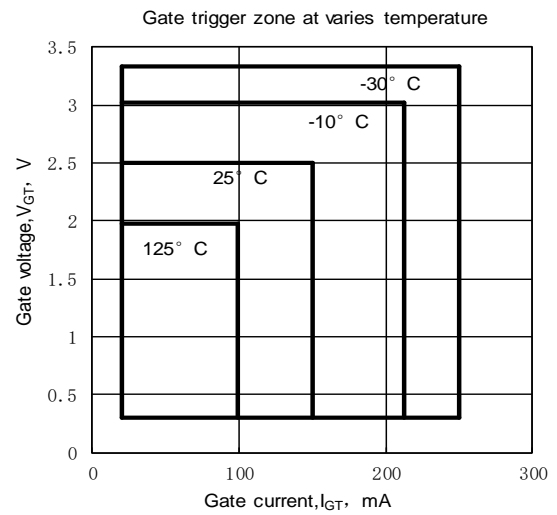
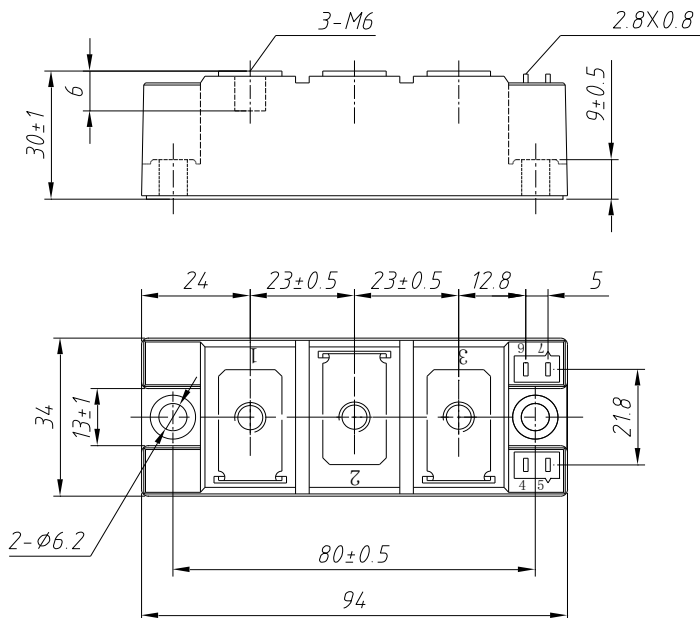
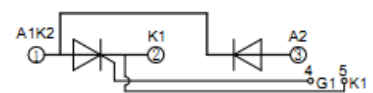

Fig.10

Outline:



MD160TH



MR160TH

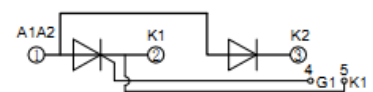

MC160TH

