

Features :

- Isolated mounting base 3000V~
- Solder joint technology with increased power cycling capability
- Space and weight saving

Typical Applications

- AC/DC Motor drives
- Various rectifiers
- DC supply for PWM inverter

V_{DSM}, V_{RSM}	V_{DRM}, V_{RRM}	Type
900V	800V	Mx110T80S
1100V	1000V	Mx110T100S
1300V	1200V	Mx110T120S
1500V	1400V	Mx110T140S
1700V	1600V	Mx110T160S
1900V	1800V	Mx110T180S

SYMBOL	CHARACTERISTIC	TEST CONDITIONS	$T_j(^{\circ}C)$	VALUE			UNIT
				Min	Type	Max	
$I_{T(AV)}$	Mean on-state current	180° half sine wave 50Hz Single side cooled, $T_c=85^{\circ}C$	125			110	A
$I_{T(RMS)}$	RMS on-state current					173	A
I_{DRM} I_{RRM}	Repetitive peak current	at V_{DRM} at V_{RRM}	125			20	mA
I_{TSM}	Surge on-state current	10ms half sine wave $V_R=60\%V_{RRM}$	125			1.9	kA
I^2t	I^2t for fusing coordination					18.1	$A^2s \cdot 10^3$
V_{TO}	Threshold voltage		125			0.8	V
r_T	On-state slope resistance					2.29	m Ω
V_{TM}	Peak on-state voltage	$I_{TM}=330A$	25			1.65	V
dv/dt	Critical rate of rise of off-state voltage	$V_{DM}=67\%V_{DRM}$	125			1000	V/ μs
di/dt	Critical rate of rise of on-state current	Gate source 1.5A $t_r \leq 0.5\mu s$ Repetitive	125			200	A/ μs
I_{GT}	Gate trigger current	$V_A=12V, I_A=1A$	25	30		200	mA
V_{GT}	Gate trigger voltage			0.6		2.5	V
I_H	Holding current			10		250	mA
V_{GD}	Non-trigger gate voltage	$V_{DM}=67\%V_{DRM}$	125	0.2			V
$R_{th(j-c)}$	Thermal resistance Junction to case	Single side cooled per chip				0.25	$^{\circ}C/W$
$R_{th(c-h)}$	Thermal resistance case to heatsink	Single side cooled per chip				0.15	$^{\circ}C/W$
V_{iso}	Isolation voltage	50Hz, R.M.S, $t=1min, I_{iso}: 1mA(MAX)$		3000			V
F_m	Thermal connection torque(M5)				4.0		N-m
	Mounting torque(M6)				6.0		N-m
T_{stg}	Stored temperature			-40		125	$^{\circ}C$
W_t	Weight				95		g
Outline	M16						

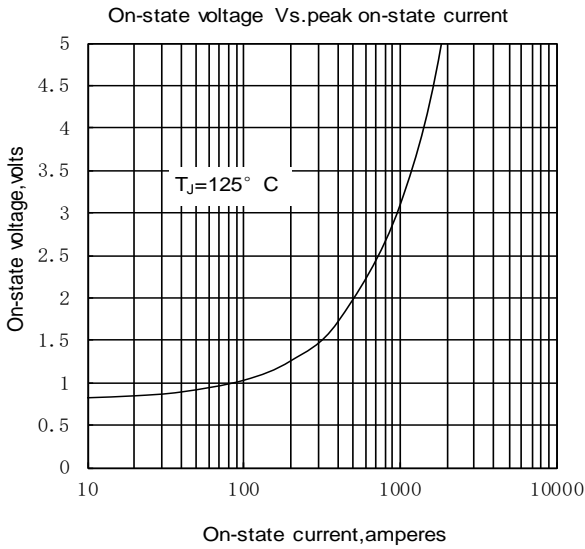

Fig1

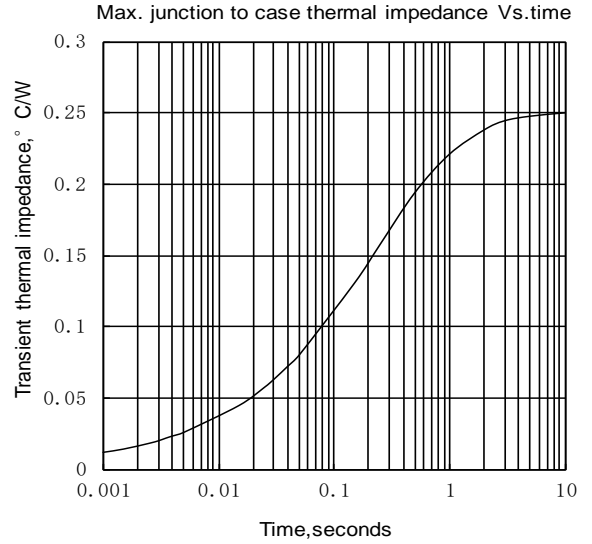

Fig2

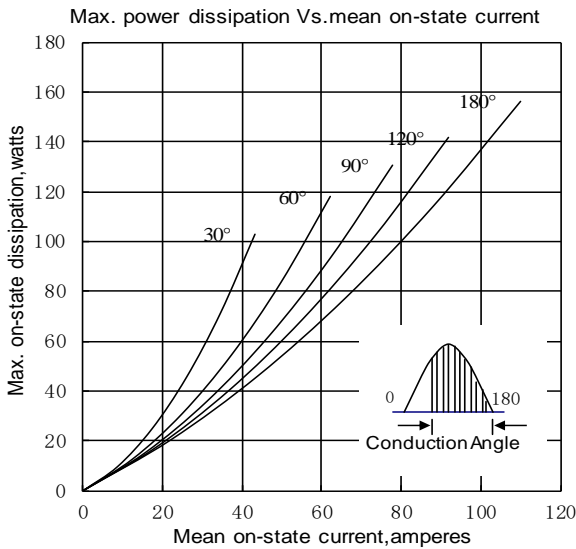

Fig3

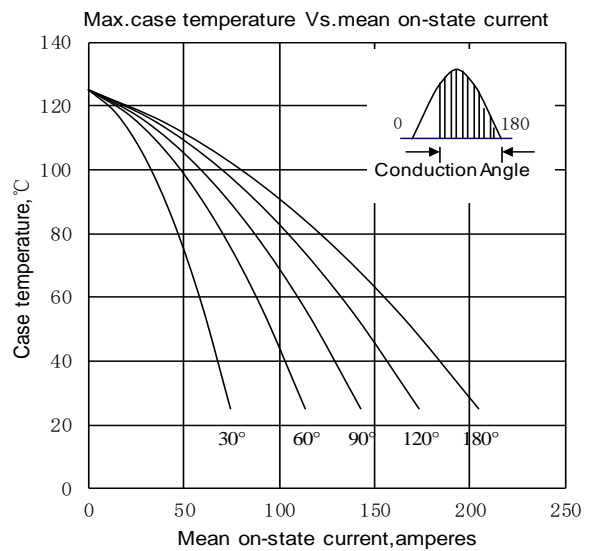

Fig4

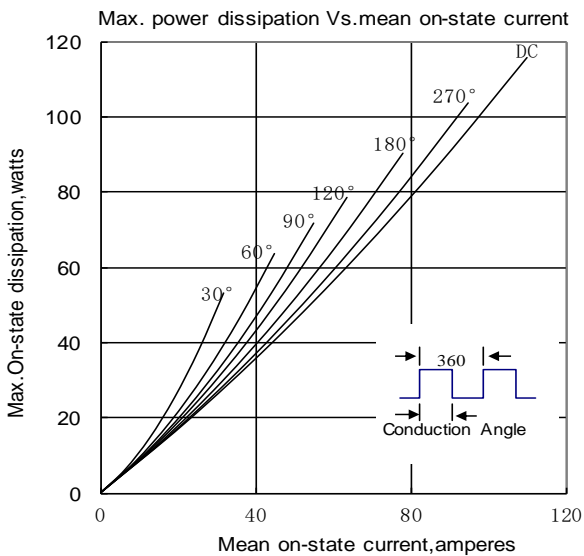

Fig5

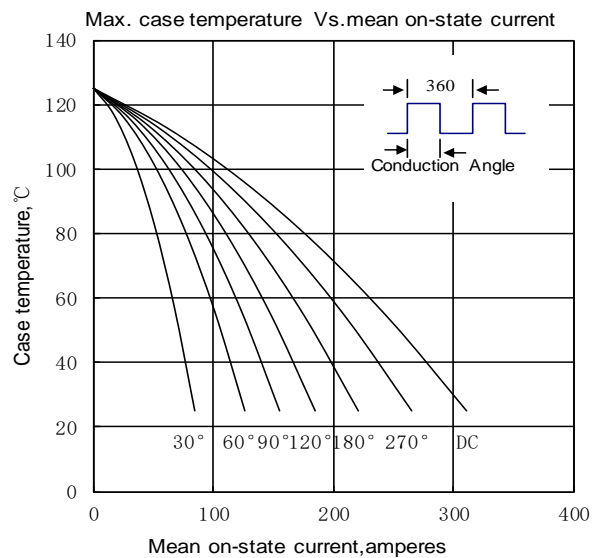

Fig6

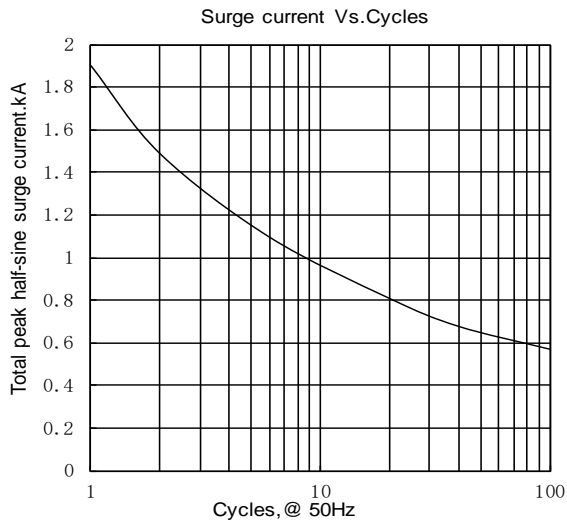

Fig7

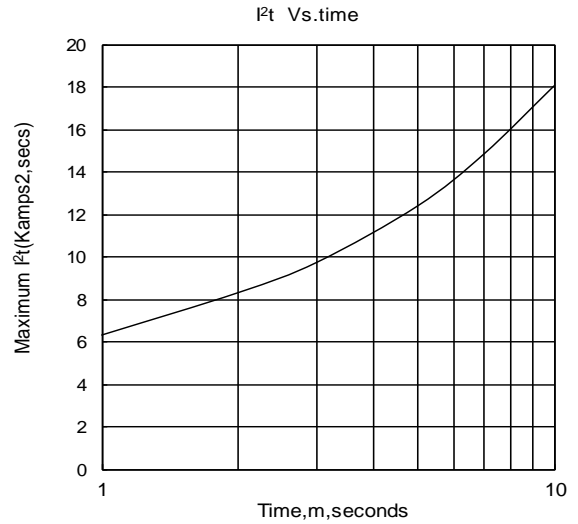

Fig8

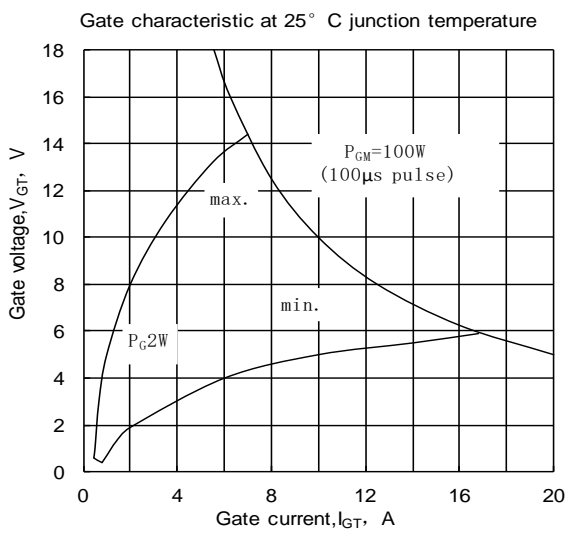

Fig9

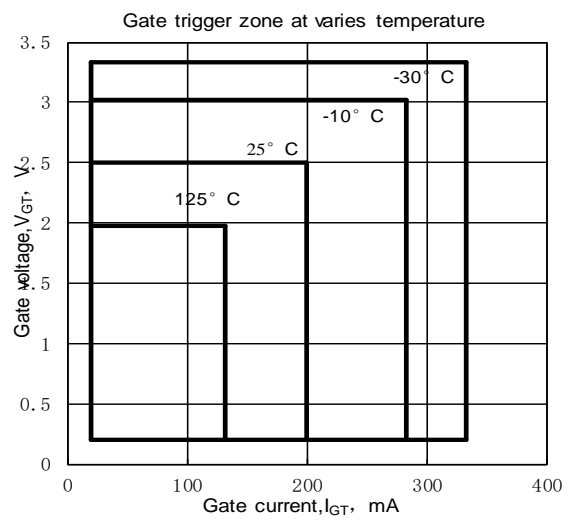
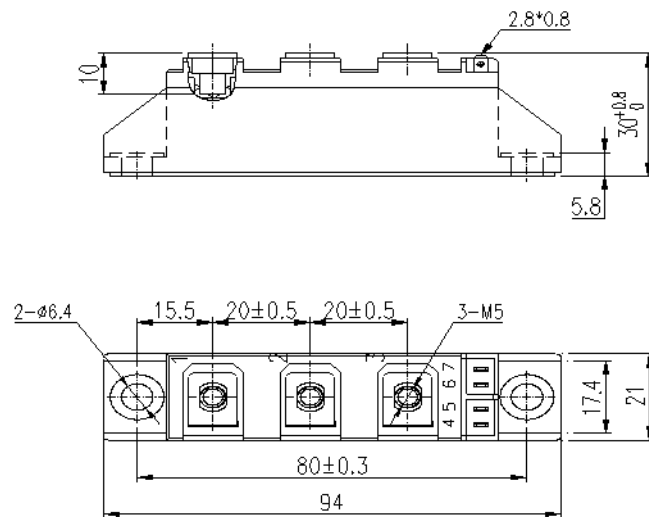
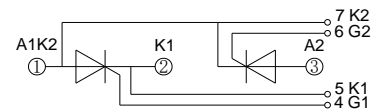

Fig10

Outline:



MD110T*S



MH110T*S

