

Features :

- Isolated mounting base 3000V~
- Pressure contact technology with Increased power cycling capability
- Space and weight saving

Typical Applications

- AC/DC Motor drives
- DC supply for PWM inverter

V _{RSM}	V _{RRM}	Type
2100V	2000V	Mx110D200
2300V	2200V	Mx110D220
2600V	2500V	Mx110D250

SYMBOL	CHARACTERISTIC	TEST CONDITIONS	T _j (°C)	VALUE			UNIT
				Min	Type	Max	
I _{F(AV)}	Mean forward current	180° half sine wave 50Hz Single side cooled, T _C =100°C	150			110	A
I _{F(RMS)}	RMS forward current		150			173	A
I _{RRM}	Repetitive peak current	at V _{RRM}	150			8	mA
I _{FSM}	Surge forward current	10ms half sine wave V _R =0.6V _{RRM}	150			2.6	kA
I ² t	I ² t for fusing coordination					33.8	A ² s*10 ³
V _{FO}	Threshold voltage		150			0.85	V
r _F	Forward slope resistance					1.80	mΩ
V _{FM}	Peak forward voltage	I _{FM} =330A	25			1.55	V
R _{th(j-c)}	Thermal resistance Junction to case	At 180° sine Single side cooled per chip				0.33	°C /W
R _{th(c-h)}	Thermal resistance case to heatsink	At 180° sine Single side cooled per chip				0.20	°C /W
V _{iso}	Isolation voltage	50Hz,R.M.S,t=1min, I _{iso} :1mA(max)		3000			V
F _m	Terminal connection torque(M5)				4		N·m
	Mounting torque(M6)				6		N·m
T _{vj}	Junction temperature			-40		150	°C
T _{stg}	Stored temperature			-40		125	°C
W _t	Weight				170		g
Outline	M01						

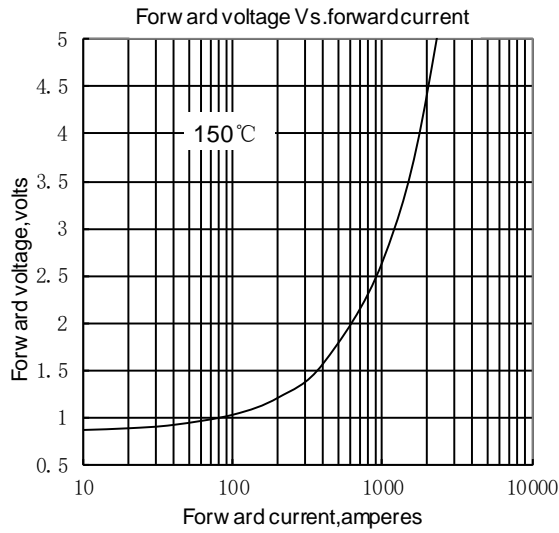

Fig. 1

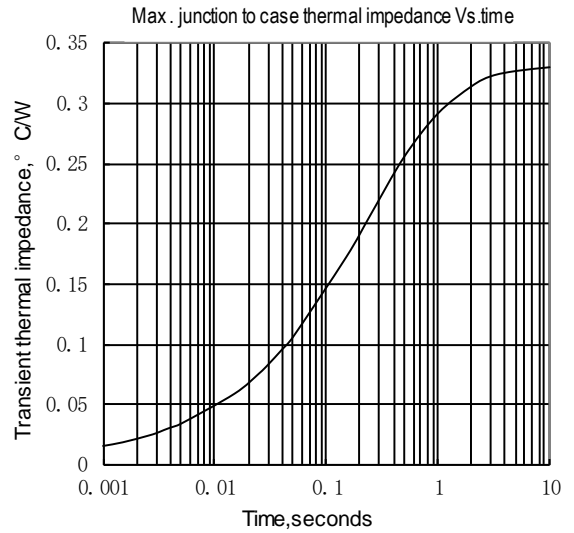

Fig. 2

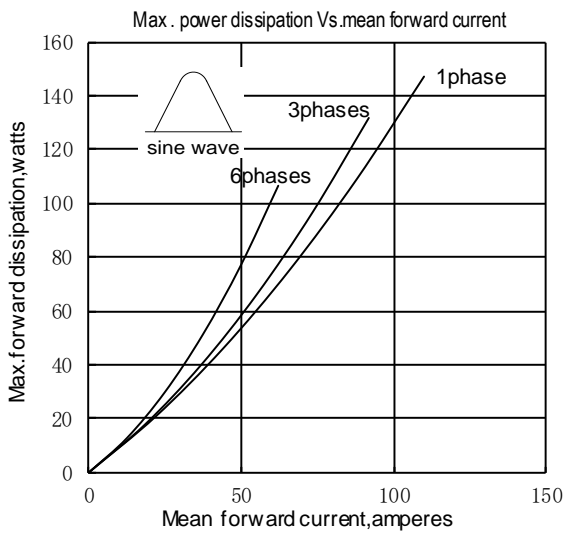

Fig. 3

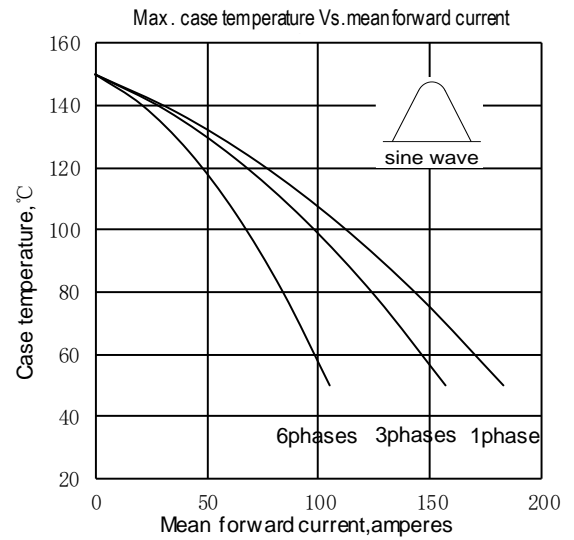

Fig. 4

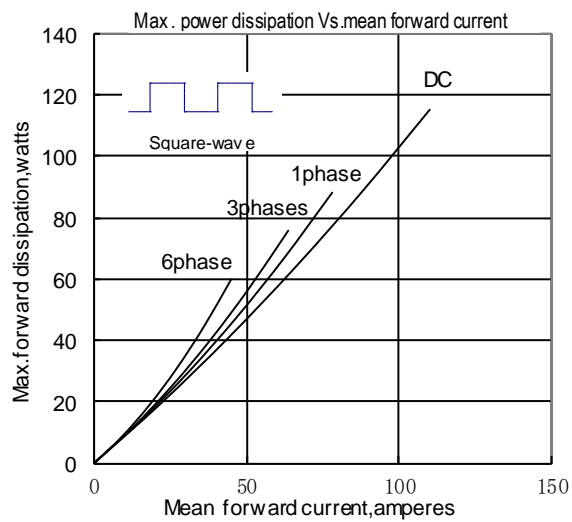

Fig. 5

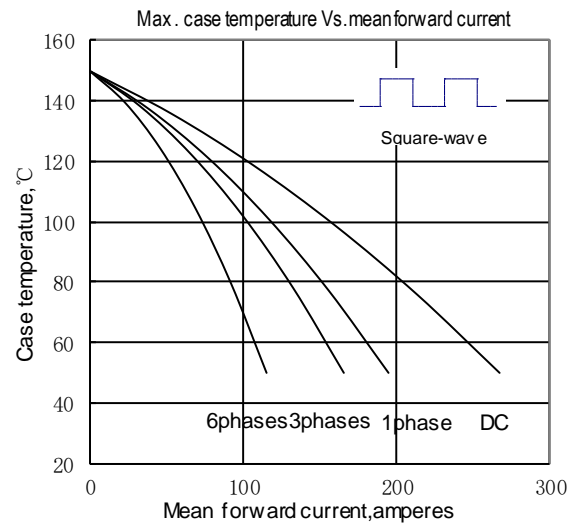

Fig. 6

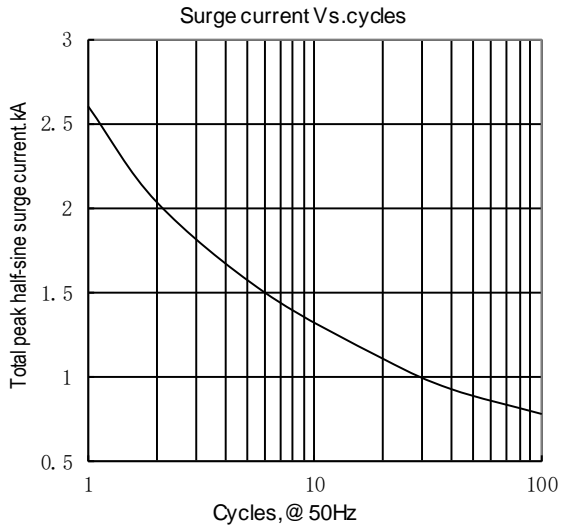

Fig.7

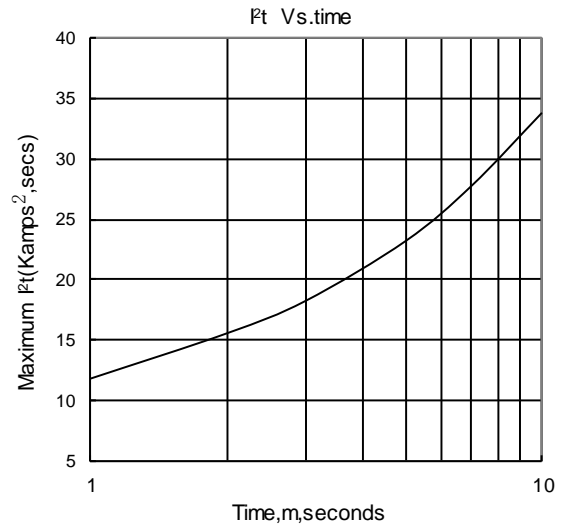
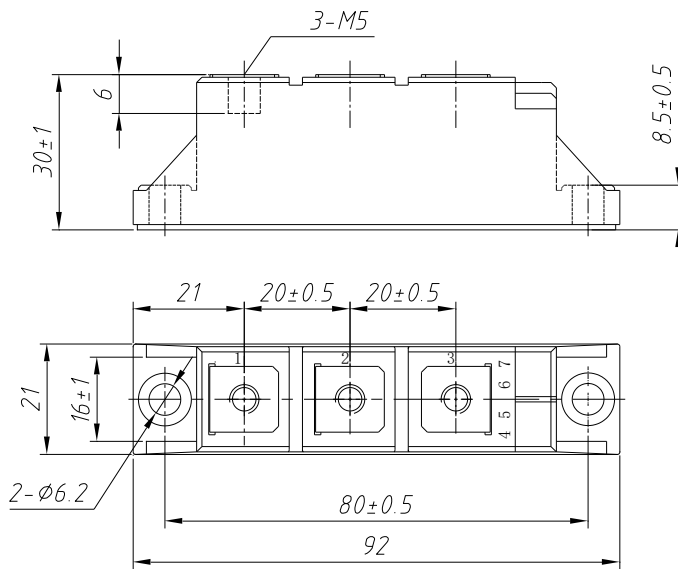
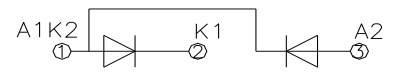

Fig.8

Outline:



MD110D



MR110D

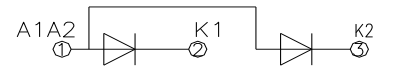

MC110D

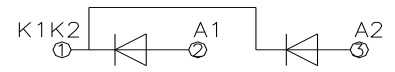

MH110D

