

Features :

- Isolated mounting base 3000V~
- Solder joint technology with increased power cycling capability
- Space and weight saving

Typical Applications

- AC/DC Motor drives
- Various rectifiers
- DC supply for PWM inverter

V _{DSM} , V _{RSM}	V _{DRM} , V _{RRM}	Type
900V	800V	MD110TH80S
1100V	1000V	MD110TH100S
1300V	1200V	MD110TH120S
1500V	1400V	MD110TH140S
1700V	1600V	MD110TH160S
1900V	1800V	MD110TH180S

SYMBOL	CHARACTERISTIC	TEST CONDITIONS	T _j (°C)	VALUE			UNIT
				Min	Type	Max	
I _{T(AV)}	Mean on-state current	180° half sine wave 50Hz Single side cooled, T _c =85°C	125			110	A
I _{T(RMS)}	RMS on-state current					173	A
I _{DRM} I _{RRM}	Repetitive peak current	at V _{DRM} at V _{RRM}	125			20	mA
I _{TSM}	Surge on-state current	10ms half sine wave	125			1.9	kA
I ² t	I ² t for fusing coordination	V _R =60%V _{RRM}				18.1	A ² s*10 ³
V _{TO}	Threshold voltage		125			0.8	V
r _T	On-state slope resistance					2.29	mΩ
V _{TM}	Peak on-state voltage	I _{TM} =330A	25			1.65	V
dv/dt	Critical rate of rise of off-state voltage	V _{DM} =67%V _{DRM}	125			1000	V/μs
di/dt	Critical rate of rise of on-state current	Gate source 1.5A t _r ≤0.5μs Repetitive	125			200	A/μs
I _{GT}	Gate trigger current	V _A =12V, I _A =1A	25	30		200	mA
V _{GT}	Gate trigger voltage			0.6		2.5	V
I _H	Holding current			10		250	mA
V _{GD}	Non-trigger gate voltage	V _{DM} =67%V _{DRM}	125	0.2			V
R _{th(j-c)}	Thermal resistance Junction to case	Single side cooled per chip				0.25	°C /W
R _{th(c-h)}	Thermal resistance case to heatsink	Single side cooled per chip				0.15	°C /W
V _{iso}	Isolation voltage	50Hz, R.M.S, t=1min, I _{iso} :1mA(MAX)		3000			V
F _m	Thermal connection torque(M5)				4.0		N·m
	Mounting torque(M6)				6.0		N·m
T _{stg}	Stored temperature			-40		125	°C
W _t	Weight				95		g
Outline	M16						

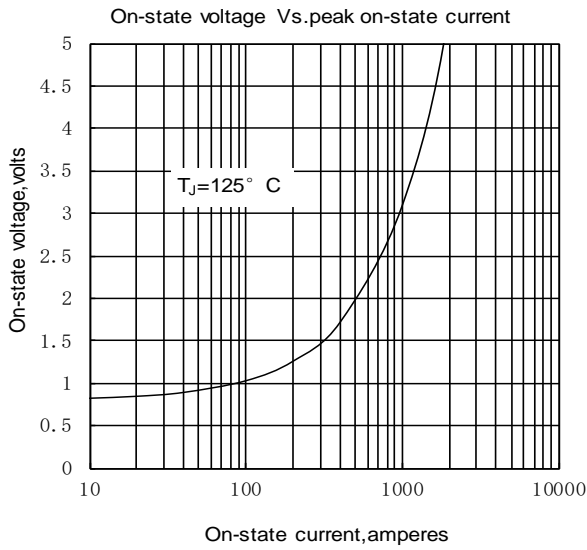

Fig1

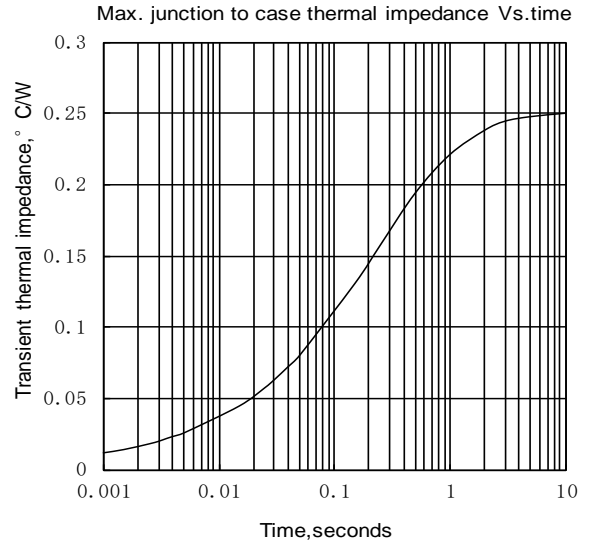

Fig2

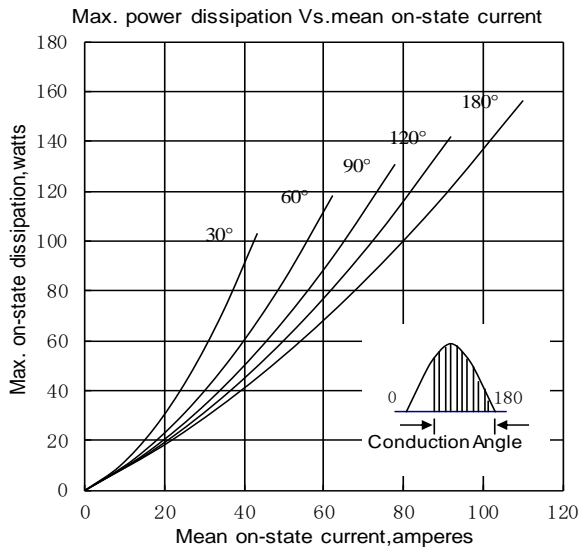

Fig3

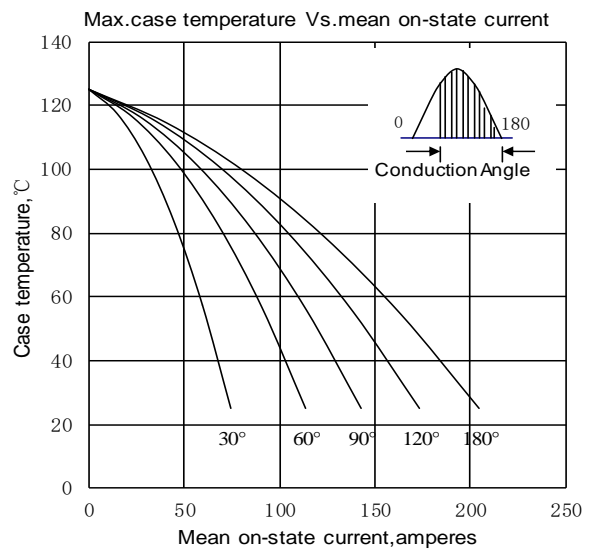

Fig4

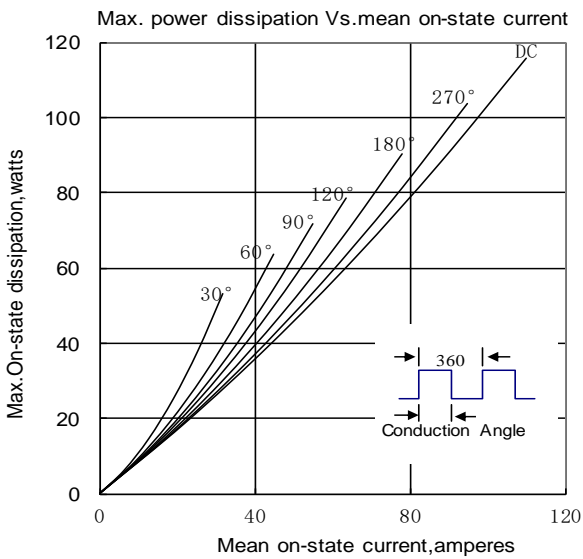

Fig5

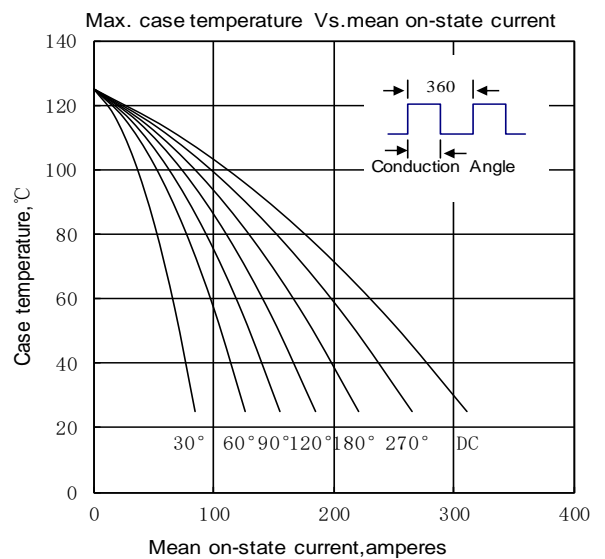

Fig6

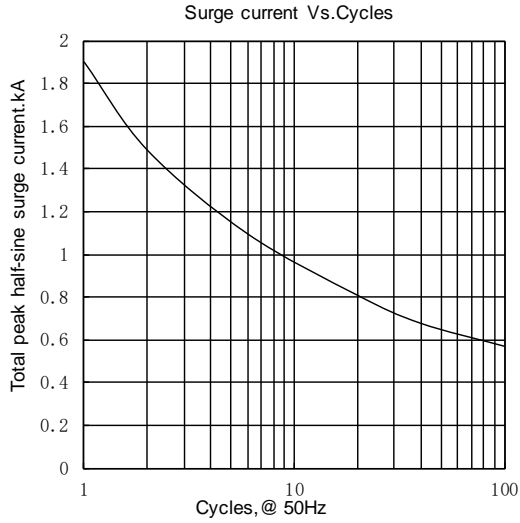

Fig7

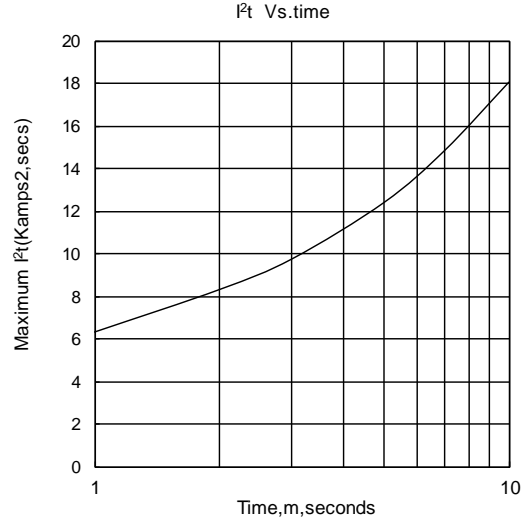

Fig8

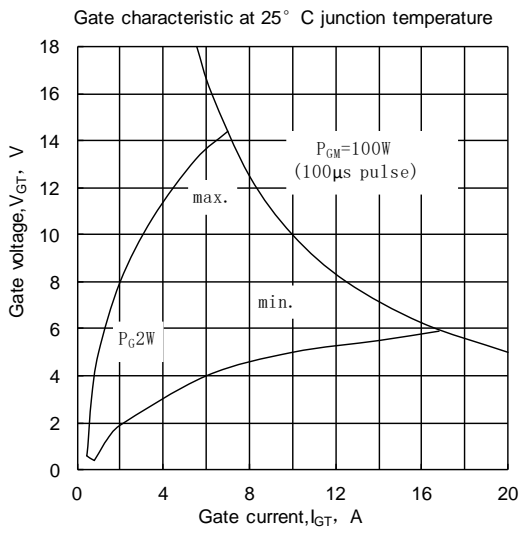

Fig9

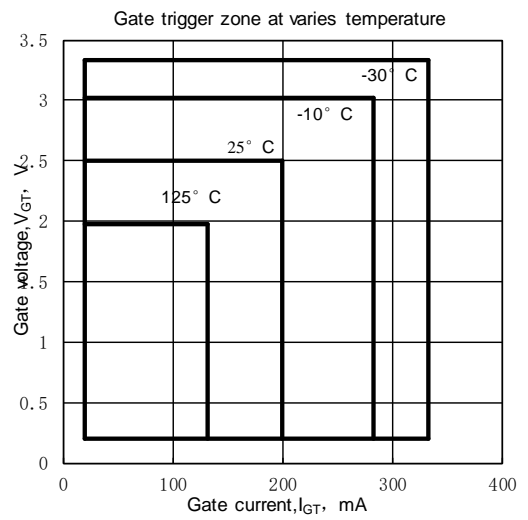
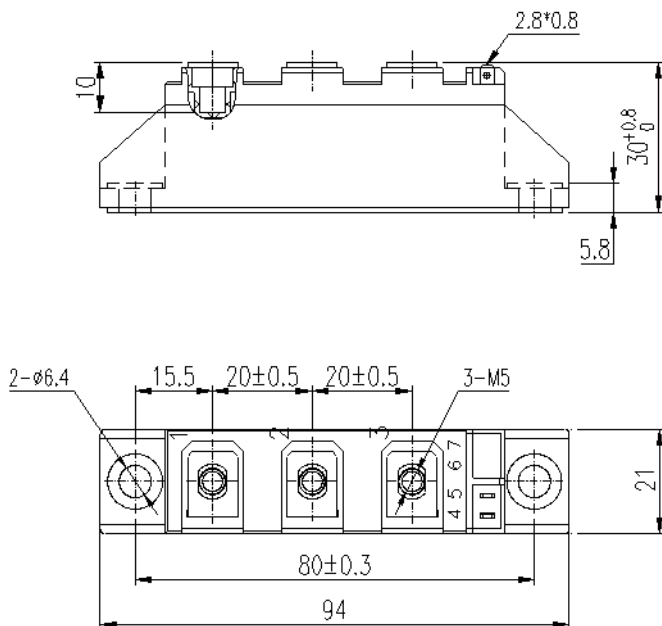

Fig10

Outline:



MD110TH*S

